

# Hybrid Recorder DR240

Advanced instrumentation technology for cost-effective data logging and data acquisition.  
Data Acquisition and Recording WINDOWS for now and the future.

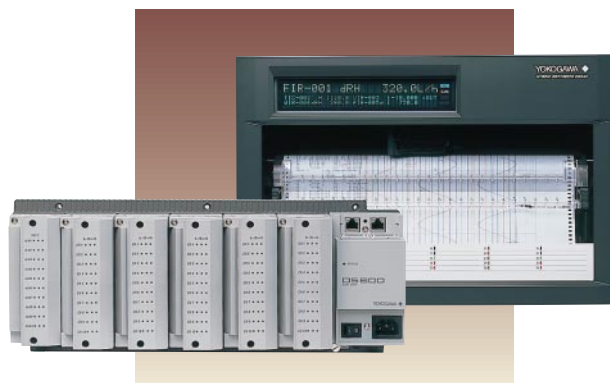

**DARWIN**  
Data Acquisition and Recording Windows

# Highly Advanced, Versatile, 250 mm Hybrid Recorder that Meets Your Present and Future Needs

# DARWIN

A highly reliable, functional expert tool-ideal for data acquisition and recording

The DR240 is a high performance panel-mounted hybrid recorder that can measure data from 10 to 300 channels in 500 ms. Compact input modules measure input variables, such as temperature, flow rate, strain, etc. and can simultaneously record and transfer the measured data to a personal computer or store it in a memory device (floppy disk).

The DR240 is available in two versions, a stand-alone model which has an integrated input, output and recording section and a maximum capacity of 30 channels. The expandable model uses input modules which can be easily expanded from 10 to 300 channels in 10-channel increments. Alarm output modules are also available. The input and output sections of the expandable model are modularized, enabling you to freely configure the optimum data acquisition environment.

This highly reliable, expandable and economical unit was developed as the next generation hybrid recorder. It also meets a wide range of needs from small-scale data logging to multi-point data acquisition.

## DR240 Stand-alone Model



### DR240 stand-alone model

This general-purpose model measures and records up to 30 channels. Specify 10, 20 or 30 channels at the time of ordering. The construction of this DR240 model provides excellent cost performance.

- Input channels: From 10 to 30 channels, connected directly to the main unit
- Measurement interval: 2 s minimum
- Universal inputs: DCV, TC, RTD, contact, power monitor (option)
- Memory devices (specified when ordering): 3.5" floppy disk drive



### High speed, accurate measurement

The DR240 expandable model has a scanning speed of 500 ms/300 channels, while the stand-alone model scans up to 30 channels in 2 seconds.

### Cost-effective

The depth and weight of the DR240 are significantly less than conventional multi-point strip chart recorders, this reducing total control panel volume.

A DR240 configuration can also greatly reduce the amount of wiring needed, particularly for remote measurements, providing a favorable cost/performance ratio.

### High expandability

The DR240 can be flexibly configured and expanded to meet a wide range of recording, small-scale data logging and multi-point data acquisition needs. The recorder accepts a large variety of inputs including: voltage, temperature (thermocouple, RTD), contact, power monitor, pulse, strain and DCA signal.

### High reliability and environmental durability

The DR240 recorder provides high reliability and performance over a wide range of environmental conditions.

### Support for efficient data processing

You can configure your personal computer based data acquisition environment with ease.

## DR240 Expandable Model

### Subunit



### Subunit



### Subunit

Up to 6 subunits can be connected.

### DR240 expandable model

Connecting the main unit to each subunit with dedicated cables, you can easily configure a multi-channel hybrid recorder.

- Input channels: The number of input channels can be increased from 10 to 300 channels in steps of 10 channels.
- Measurement interval: 500 ms maximum
- Inputs: Universal (DCV, TC, RTD, DI), DCV/TC/DI dedicated, power monitor, pulse, strain and direct current (mA) modules
- Up to six subunits can be connected to a main unit. Up to six input and/or output modules can be connected to one subunit.
- Subunits can be separated from the main unit by up to 500 m total cable length.
- Memory devices (specified when ordering): 3.5" floppy disk drive



# Highly Expandable and Cost Effective

## DR240 Expandable Model

# DARWIN

A highly reliable, functional expert tool-ideal for data acquisition and recording

The DR240 expandable model enables you to start with a small number of channels, and conveniently expand, up to 300 channels. The architecture of the DR240 allows you to increase the number of input and/or output modules as your application needs change.

The versatility of the DR240 recorder enables you to freely configure a recording/data acquisition environment that matches your particular application, while effectively reducing your initial investment.

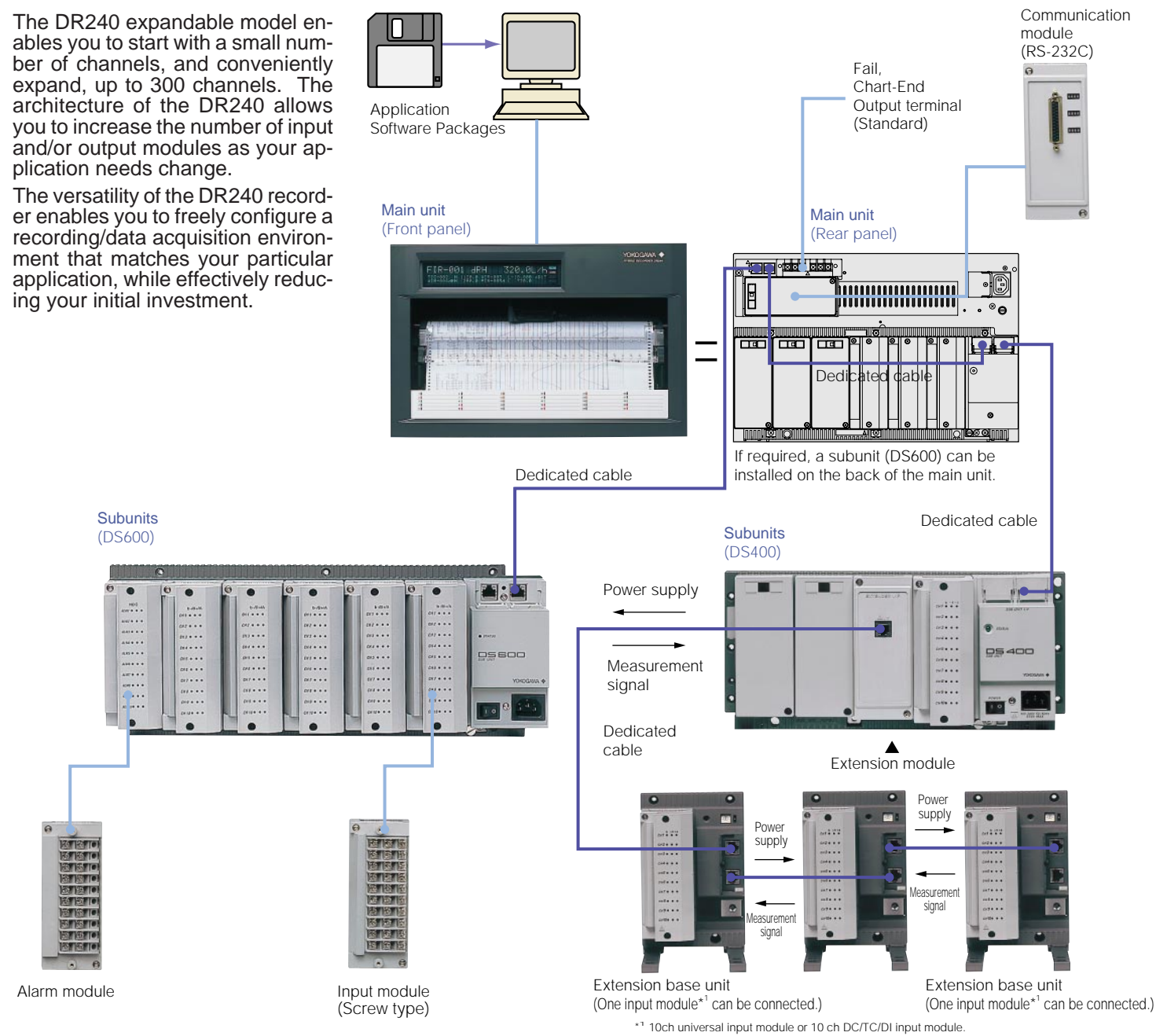

### Input Module

The input module is a 10-channel\* small remote multiplexer that A/D-converts the measured signals as fast as every 500 ms.\*\* The input signals include not only DC voltage and temperature, but also contact, power monitor, pulse, strain and DCA (mA) signals.

\* : Power monitor modules are 2- or 6-channel.  
\*\* : If input modules of different measurement intervals are mixed, the resulting measurement interval is that of the longest interval input module.

#### ● Universal Input Module

The universal input module permits measurement of DC voltages between 20 mV and 50 V, thermocouple inputs, RTD inputs, and contact signals in up to 500-ms intervals.

Other cost-effective universal input modules are available that measure data from 20 or 30 channels in 2-second intervals, and low-cost dedicated input modules that accept voltages and thermocouple outputs.

#### ● Power Monitor Module

The power monitor module receives AC voltage or current input signals and measures RMS values, active power, apparent power, reactive power, frequency, power factor and phase angle. The minimum measurement interval (data update cycle) is 2 seconds.

#### ● Pulse Input Module

The pulse input module receives TTL or contact signals from a flow or tachometer, and counts and integrates the number of pulses. The minimum measurement interval is 0.5 second and the data update cycle is one second.

#### ● Strain Measurement Module

The strain measurement module measures static strain, and comes in two types. One incorporates a 120 or 350 Ω bridge resistor, the other is for connecting an external bridge box. One module enables data in 10 channels to be measured, however, it requires two slots worth of space. The minimum measurement interval (data update cycle) is 500 ms.

#### ● Direct Current (mA) Module

The shunt resistor (100 Ω) is pre-installed to measure the DCA signal.

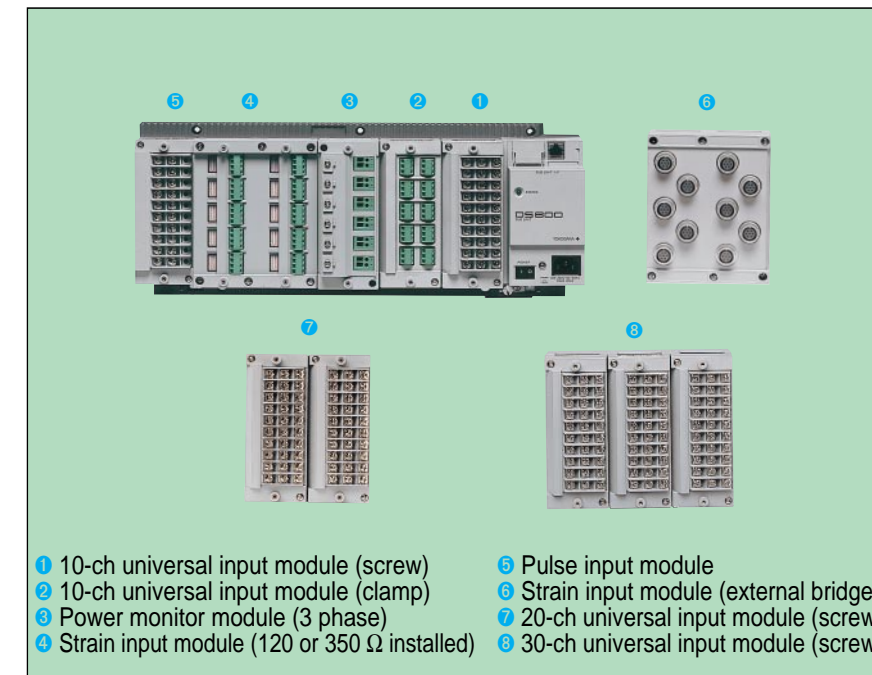

### Alarm output module

This is a 4-channel or 10-channel output module which outputs contact alarm signals according to preset conditions. You can set four alarm levels per channel (Choose from upper limit, lower limit, delta high limit, delta low limit, or rate-of-change). You can install alarm output modules on the subunits.

### General-purpose communications module

You can connect a Ethernet, RS-422A/RS-485, RS-232C, or GP-IB general-purpose communications module to the back panel of the main unit. All measured data is transferred in real time via the installed communications module.

### Ethernet Module

The Ethernet module enables you to achieve high-speed, multi-channel, remote data communication via Ethernet. The module supports all commands generally used for DARWIN and permits data access from a maximum of four personal computers (configured to do so with user-created software).

### DI/DO module

This module enables the DR240 hybrid recorder to be controlled\* from a remote location, and also outputs the chart end and recorder fail signals to your external annunciator.

\*Remote control functions:  
Start and stop recording  
Change chart speed  
Start message printing  
Start and stop memory sampling  
Control statistical calculation interval

The DR242 expandable model incorporates the fail and chart end output as standard features.

### Extension module

Using an extension module, you can supply power directly from a subunit for each input module\*1, mounted on an extension base unit. Also, connecting an extension module on a subunit allows connection of up to three input modules as well as three extension base units, over a distance of up to 30 m.

\*1: 10-ch universal input module or 10-ch DCV/TC/DI input module

### DR240 expandable model

The DR240 expandable model consists of a main unit, subunits, input/output and communications modules. Connecting the main unit to multiple subunits with dedicated cables of up to 500 m total length, you can easily configure a recording/data acquisition environment ranging from 10 to 300 channels. Another key feature is its ability to scan up to 300 channels every 500 ms. You can also install one subunit on the back of the main unit of the hybrid recorder.

### Main unit (DR242)

The DR242 acquires data measured by the input modules installed on each subunit, records the data in real time and/or transfers it to a PC using a general-purpose communications interface, and also stores it in a memory device. You can connect a communication module, Ethernet, RS-232C, RS-422/485 or GP-IB, and also a DI/DO module to the main unit. An input module, on a subunit (DS600), can be installed on the back of the main unit.

### Subunits (DS400, DS600)

A subunit acts as an interface for connecting input modules to the main unit of the DR240 expandable model. There are two types of subunits, the DS400 which permits connection of up to four input and output modules, and the DS600 which permits connection of up to six input and output modules. Normally, when a subunit is connected, it will be at a separate location from the main unit. (When a subunit DS600 is mounted on the back of a main unit, a dedicated cable is required between them.)



Dedicated cable

### DV250-001 Cable adapter

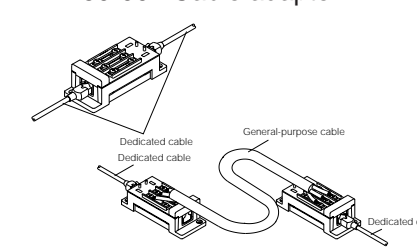

The DV250-001 cable extension adapter is used as a junction terminal for extending a dedicated cable that connects between DARWIN units or as an adapter for connecting the dedicated cable to a different cable.

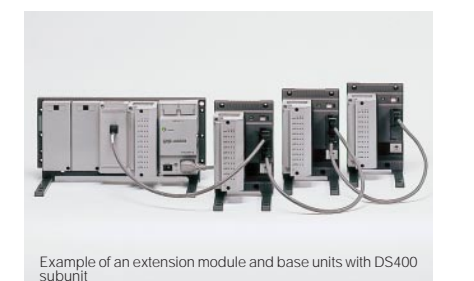

Example of an extension module and base units with DS400 subunit

# Structural Simplicity

## DR240 Stand-alone Model

This model has a simple building block architecture, and comes with I/O and communications modules installed on the back of the main unit.

Specify 10, 20 or 30 input channels, and desired options, at the time of ordering.



### Simple integrated construction

You can connect 10, 20 or 30 channels directly to the main unit. The DR240 stand-alone model, which comes with I/O modules already installed, is a cost-effective general-purpose model. The external appearance, recorder function, memory and communications functions of this model are identical to those of the expandable model. Because this model is of integrated construction, it can be carried about easily.

### Universal and power monitor range

Universal inputs permit measurement of a variety of inputs including DC voltage, thermocouple, RTD and contact signals. Low-cost model for measuring only voltage and thermocouple signals is available. You can also select power monitor (optional) for measuring AC voltage and current.

### Variety of options, including general-purpose communications and DI/DO functions

General-purpose communications (Ethernet, RS-232C, RS-422A/485, and GPIB), 10-point SPDT alarm output relays, DI/DO (2 alarm relays, remote control of recorder, CPU fail and chart end contacts). Specify your required options when ordering.

### Comparison of expandable and stand-alone models

Model	DR240 hybrid recorder	
	Stand-alone model	Expandable model
Features	Integrated type that can measure up to 30 channels. Can be carried about easily, and is suitable for small-scale data logging.	Expandable up to 300 channels. By connecting subunits to the main unit, you can perform multi-channel measurement with the minimum amount of wiring.
Number of input channels	10/20/30 channels (Specify when ordering.) Connect to the recorder main unit.	10 to 300 channels: Connect to subunits.
Expanding or changing inputs	Not applicable (Fixed according to ordered quantity.)	You can expand the number of inputs in 10-channel steps, and also change the kinds of inputs.
Inputs	Universal, DCV/TC/DI, power monitor (optional)	Universal, DCV/TC/DI, power monitor, strain, pulse, direct current (mA)
Connection of subunits, and remote measurement distance	Not applicable	Up to six subunits can be connected: 500 m max.
Max. scanning speed	2 s/all channels	0.5 s/all channels
Max. recording speed	Common (2 s/all channels)	
Recording function	Common	
Memory device	Common (3.5-inch FDD)	
Indication and operation method	Common	
Computation channels	Max. 30 channels	Max. 60 channels
Alarm output	12 points	10 to 300 points
Power supply	AC or DC (specify when ordering.)	AC

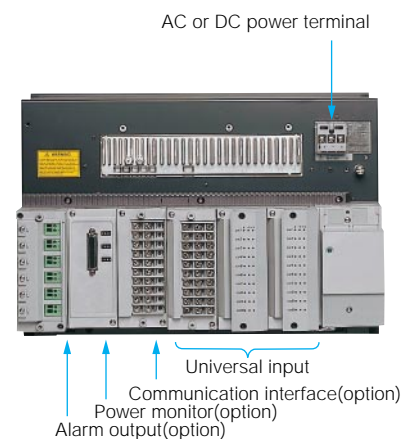

Rear panel of the stand-alone model

# Versatile Operator Display and Ease of Operation

## Monitoring/Configuration Functions

The DR240 incorporates a 3-line, large vacuum fluorescent display (VFD) which can be used as a process monitor enabling you to readily view data or

check alarm statuses, even from a remote location. The DR240 is interactively configured using the easily-read display.

### Versatile display formats



The large vacuum fluorescent display shows a total of 102 characters, one line of 22 large characters, and two lines of 44 smaller characters. It displays the measured results and alarm statuses in an eas-

ily readable format. There are a large number of display formats including up to 5-ch digital data, bar graph, and alarm relay status. Tag names and engineering units are displayed, making process monitoring easier than ever.

### Simple setup

The DR240 is interactively configured using the 102 character VFD display. The setup items are always displayed in large characters at the top, with the range of choices and other information displayed at the bottom. In addition, the setup menus separate items that are frequently used from those that are rarely changed once set, thus simplifying configuration.



Input range and span configuration menu



Chart speed setup menu

### Replacing consumables



The ink ribbon is a quickly replaceable cassette. Also, the chart holder is a pull-out type enabling the chart to be replaced with ease. The ink ribbon and chart paper are completely interchangeable with the ribbon and paper used in YOKOGAWA's HR2400 hybrid recorder.

### Removable input/output modules



The input and output sections are of modular construction, enabling them to be removed when performing wiring. Also, the universal input modules are available with either screw or push-in (clamp) type terminals.



# Clear Hybrid Recording Functions

A recorder's performance is measured by the readability of the information on its printed chart. The DR240 can record clearly, in 10 colors, data from all measurement points, at 2-second intervals. It has a wide variety of recording functions including

analog trend recording over an effective recording width of 250 mm, recording of digital measured values, recording of various messages, zone recording, and partially compressed and expanded recording, that help interpret the data.

- High speed recording at 2-second intervals
- Versatile recording formats

- Programable ten-color recording

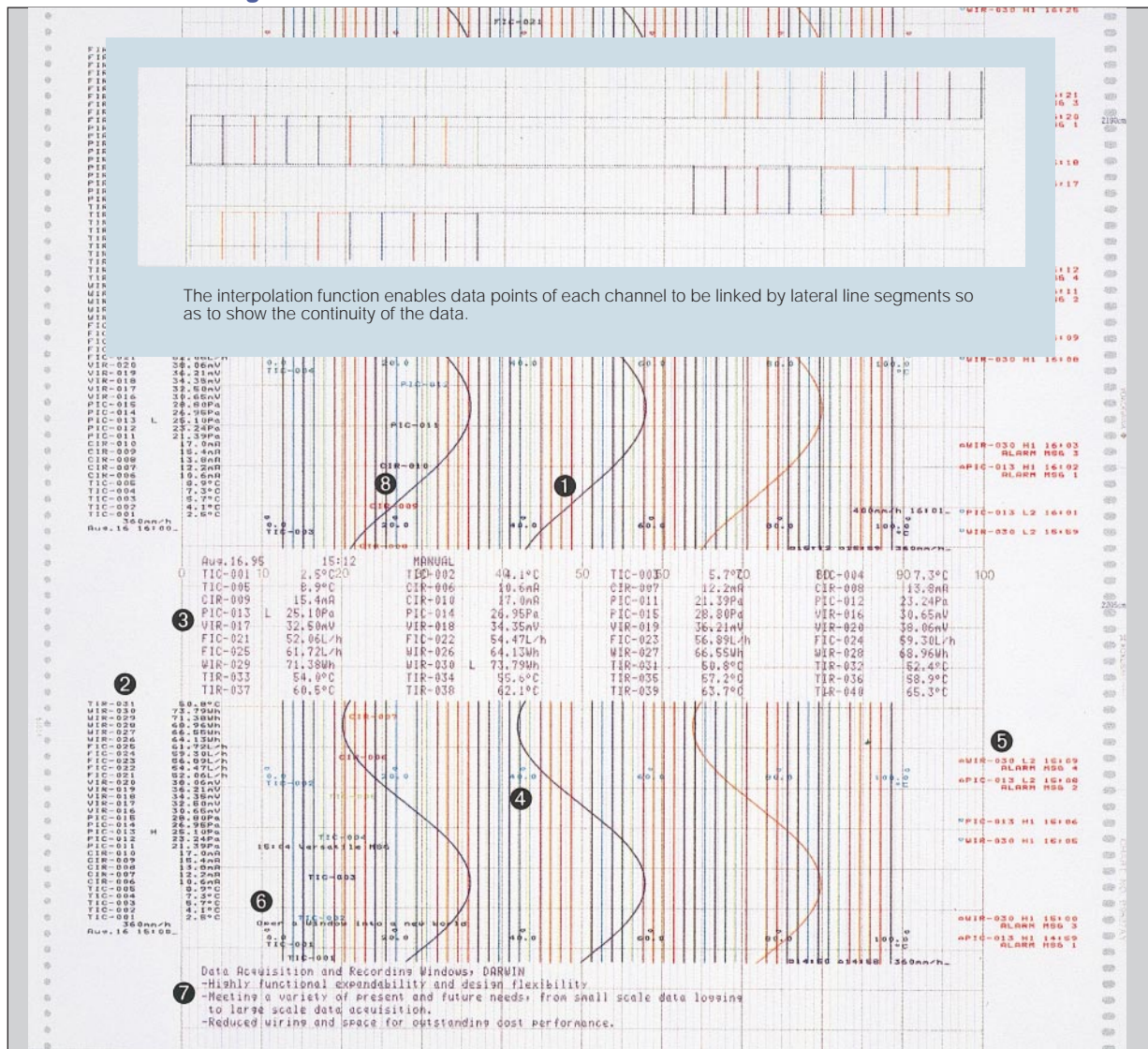

- (1) Analog trends  
Records clearly in 10 colors. You can assign the recording color to each channel.
- (2) Digital recording  
Measured values are recorded digitally either at an interval based on the chart speed, or at your specified interval. You can also start the recording of data by a remote contact input.
- (3) Manual recording  
By pressing a key, analog recording can be interrupted and measured values of one scan recorded digitally.
- (4) Alarm printout  
A change in the alarm status (ON/OFF state and time, for each channel) is printed out.

- (5) Scale printout  
The recording scale is printed out for each channel.
- (6) Message printout  
The contents of a preset message are printed out by pressing a key, contact closure on a remote control terminal, or when an alarm is detected. You can preset up to five messages of 16 characters each.
- (7) Header printout  
Headers are printed as comments (five rows of 80 characters) for experiments or process monitoring.
- (8) Printing channel No. and tag No.  
The channel number or tag are printed periodically.

# PC-Friendly

## DARWIN DAQ32

### Data Acquisition software

In addition to performing real time recording in the field and saving measured data to a removable memory media, the DR240 functions as a PC based high speed multi-point data acquisition unit. Various kinds of application software are available.

Software for configuration and data acquisition, and software for converting data saved to a removable memory device, is available. This application software makes your tasks of configuration and data acquisition quick and easy.

### DARWIN DAQ32 Software

The data acquisition software 32 (DAQ32) is the standard software for common use with all the data gathering instruments in the DARWIN series. The software includes hardware setup, simplified data logging, simplified data viewing, data conversion (Excel, Lotus 1-2-3 or ASCII format), preference setting, system diagnosis and calibration functions, all in one package. All models of the DA100 data acquisition unit and DC100 data collector come standard with this software. For each model of the DR130, DR230 and DR240 hybrid data recorders, you can specify whether software is necessary or unnecessary when ordering. When you specify software as "necessary," DAQ32 software comes standard with the model. DAQ32, which has been developed for use with 32-bit operating systems, is designed to run under Windows 95, Windows 98 or Windows NT4.0.

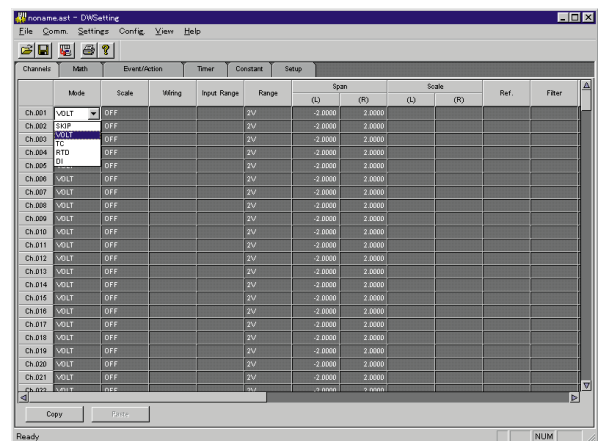

Example of hardware setup display

### DARWIN DAQ32Plus Software

The data acquisition software 32PLUS (DAQ32Plus) is the enhanced software for common use with all the data gathering instruments in the DARWIN series. Like the standard DAQ32, this software includes hardware setup, simplified data logging, simplified data viewing, data conversion (Excel, Lotus 1-2-3 or ASCII format), preference setting, system diagnosis, calibration, and tag number setting functions, all in one package. DAQ32Plus is far more powerful than DAQ32, however, in terms of the data monitoring and logging functions. It contains a number of additional functions not found in DAQ32. Additions include a display of up to 30 data groups each having a maximum of 32 channels' worth of data per window (as compared with the DAQ32's display of up to 2 data groups each having a maximum of 10 channels' worth of data per window); displays of various meters including level meters, analog meters and thermometers (not offered by DAQ32); alarm displays; as well as a DDE server, logger autostart, retry, password and tag setting function. DAQ32Plus, which has also been developed for use with 32-bit operating systems, is designed to run under Windows 95, Windows 98 or Windows NT4.0.

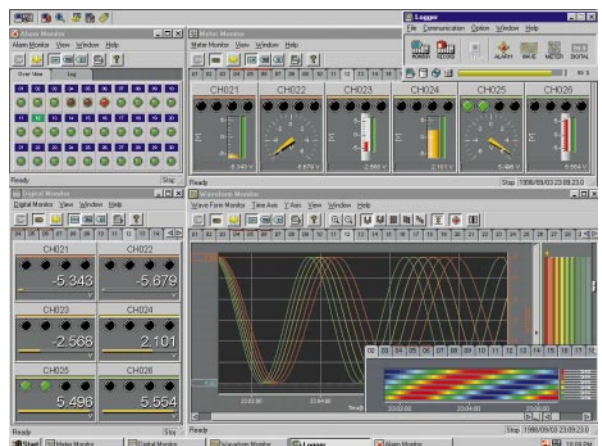

Example of data logging display

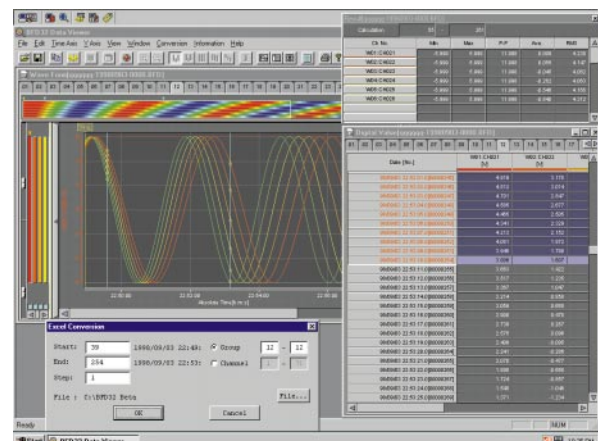

Example of data viewing display

# Application Versatility

The DR240 provides many economic benefits for the user, such as reduced wiring for remote measurement, space saving due to compact design, and optimized signal conversion costs due to the availability of a large variety of input modules.

In addition, it provides superb environmental ruggedness, and onboard computation and memory functions, enabling it to be used for a wide range of applications.

## Remote Measurement Reduces Wiring (expandable model)

You can connect subunits to a main unit over a distance of up to 500 m using a single dedicated cable. Consequently, you can greatly reduce field wiring and installation costs. For example, in the case of a 60-channel thermocouple input, 120 wires must normally be connected to the main unit, but by using a subunit you can replace these wires by

a single cable.

### ● Convenient power to the input modules

By using an extension module, you can supply power to each input module directly from the main unit or subunit.

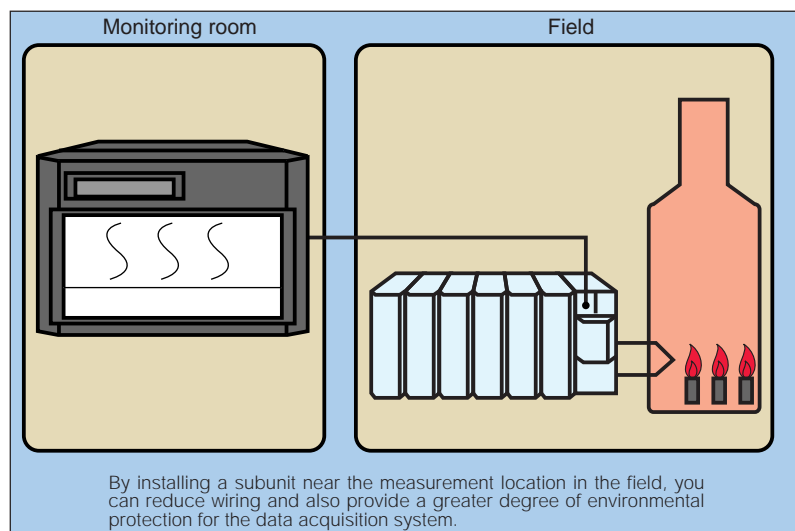

## Complete channel isolation and high-voltage measurement

Channels at the input circuit are fully isolated with high-voltage solid-state relays.\* The DR240 can withstand a common-mode voltage of up to 250 VAC\*\* rms and a withstanding voltage of up to 1500 VAC\*\* (for a duration of one minute). These features ensure that the model can be used even for multi-point measurement in the field.

\* RTD and pulse inputs share a common line within the same module.

\*\* Depends on module types.

## Superb environmental ruggedness

Every effort has been made in the design of the DR240 to reduce power consumption, thereby minimizing temperature rise. As a result, the subunits can be operated over an ambient temperature range of -10 to 60°C. The DR240 can also withstand severe conditions encountered in the field.

The front door of the main unit of the recorder is of dustproof and drip-proof construction (conforms to DIN 40050-IP54), thus preventing dust or water droplets from getting inside the unit when installed in a panel.

## Max. 500 ms/300 channel high speed measurement (expandable model)

Parallel processing of data is used by the dedicated A/D converter inside each input module. 1 Mbps high speed data transfer is accomplished between the main unit and each subunit. Furthermore, the use of a distributed multi-CPU control method for the overall system achieves high speed measurement of data from 300 channels over an interval of 500 ms. The DR240 has a time axis resolution four times that of the previous model (DA2500E), achieving better time synchronization between channels.

## Space saving due to compact design

The depth of the main unit of the DR240 hybrid recorder has been greatly reduced: it is about 60%\* of previous models in the case of the 60-channel model, and about 80%\*\* in the case of the 30-channel general-purpose model. Also, the use of high breakdown voltage solid state relays and a planar transformer developed by YOKOGAWA has

enabled the volume of the 60-point input remote measurement section to be reduced to 1/5\*\*\* of that of previous models, resulting in a highly compact unit. The mass of the unit has also been reduced to about 1/2\*. This makes for more efficient use of control room or laboratory space and reduces total costs.

\* Compared to YOKOGAWA's HR2500E, including the input measurement section

\*\* Compared to YOKOGAWA's HR2400, including the input measurement section



\*\*\* Compared to YOKOGAWA's DA2500E remote scanner plus a subunit in which six input modules are installed



## Computing functions

The main unit of the DR240 with optional MATH feature can perform the four arithmetic operations, integration of measured data, and computations such as detection of maximum and minimum values, in realtime. Even without the optional feature, the DR240 can compute linear scaling, difference and moving average. The results of such computations are transferred with the measured data to a PC, thus reducing system requirements on the PC and also resulting in more efficient analytical processing.

The main computing functions are as follows. (The shortest computation period differs depending on the kind of computation.)

### Standard computing functions

Linear scaling, moving average, differential calculation, pulse integration (when a pulse input module is recognized)

### Optional functions

The four arithmetic operations, logic operations, related operations, calculation of absolute and relative values, and statistical calculations (maximum, minimum, mean, and integrated values for fixed intervals)

#### ● Moving average function

This function renews the measured value while calculating the moving average, is effectively monitoring the trend of a varying input signal over a long period. It can also be used as a digital filter when noise components are present on the input signal. You can set the number of

moving average scans by selecting a value between 2 and 64.

#### ● Batch integration

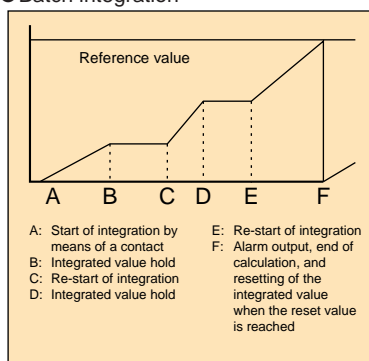

By using the DR240 in combination with the optional DI/DO module or alarm function, you can easily perform batch processing.

### Report function (/M3)

You can calculate the maximum, minimum, average values, and integrated value of the measured results, and print hourly, daily and monthly reports. The calculated values are also recorded in the report results.

### Memory function

You can select a floppy disk function with 512 kB SRAM capability for storage of information on a removable media. You can save several configuration setups and in addition store the measured data before and after an alarm, and also calculated values.

You can record the memorized data on DR240 chart, transfer it off-line to a PC, or analyze it or make it into a report using commercially available spreadsheet software.

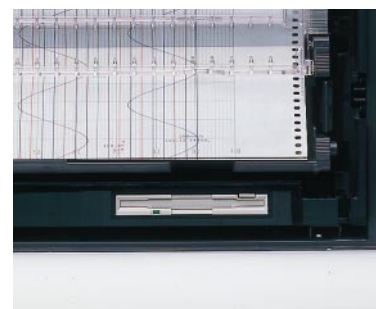

#### ● You can save the measured data in the following cases:

- By manual command or when a communications command is input
- When an alarm is detected
- When the end of the chart is reached

#### ● The save modes are as follows:

- Single: Data of the specified length is sampled once only.
- Repeat: Data of the specified length is sampled exactly the number of times specified in advance.

\* When measured values are saved to a floppy disk, they are first stored in the buffer memory (512 kB DRAM).

## Other standard functions

Function		Description
Input	Integration mode selection	You can select the 50/60 Hz or 10 Hz integration mode. The 10 Hz integration mode is useful when power line noise containing both 50 Hz and 60 Hz components is superimposed on the signal. (When the 10 Hz integration mode is activated, the minimum measurement interval is 4 s.)
	Low-pass filter	You can insert a low-pass filter in the path of a signal on which noise components are superimposed. (When the filter is ON, the minimum measurement period becomes more than 3 seconds, depending on the input types and channels.)
	Scaling	The input signal is displayed and/or recorded as an industrial quantity or a physical quantity.
	Burn-out	When the thermocouple input goes open circuit, the indicator moves to the 100% or 0% side.
	Differential calculation	The difference between the reference channel and measured channel is measured.
Record	Zone recording	The recording area can be set freely for each channel.
	Partially compressed and expanded recording	Unimportant parts are compressed, and only necessary parts are expanded, thus enabling the recording resolution to be increased.
	Group channel trend	Only channels that belong to the specified group are recorded. Switchover between groups can be done using a remote contact.
	Alarm generation channel trend	Trend recording takes place only for channels that emit an alarm.
Setting	Memory backup	The set data is protected by a lithium battery inside the unit.
	Security	The unit comes with a standard password lock function, preventing mis-operation and also protecting the set data.
Alarm	Re-breakdown re-alarm	The alarm output can be refreshed when an alarm is emitted.
	Hold function	Once an alarm is emitted, the alarm indication and relay state are held until the operator acknowledges the alarm.
	Switchover between excitation and non-excitation	The alarm mode can be switched between the alarm output relay excitation/non-excitation state.

# Increased Reliability

YOKOGAWA has Continually Improved its Measurement Technology for Your Benefit

The history of YOKOGAWA in strip chart recording instruments can be summarized as the provision of the world's most reliable and readable recorders, with unmatched performance, over the last fifteen years. In 1981, YOKOGAWA developed the Model 4088 hybrid recorder which was the first dot printing type recorder in the world to contain a microprocessor. Since then, we have continued to make many technical breakthroughs, including the

non-contact ultrasonic position detector, and high breakdown voltage (HBV) solid state relay, bringing multipoint recording closer to perfection.

This commitment to you is also evident in the DR240 hybrid recorder, which uses YOKOGAWA's advanced technologies to help you achieve higher reliability and compactness, and improved PC-compatibility.

## High breakdown voltage solid state relay (SSR)

Developed by YOKOGAWA, the SSR switches the inputs when performing multi-channel measurement. A semiconductor device takes the place of the contacts and drive part of a mechanical relay, thus overcoming the problem of defective measurement caused by faulty or worn contacts of the mechanical type relay. YOKOGAWA's solid state relay has a high breakdown voltage (1500 VDC), enhancing safety in the field. Also, its low leakage current (1 nA) enables the very low level voltage signals from a thermocouple to be measured with high accuracy. YOKOGAWA currently uses this SSR in its hybrid recorders and the advanced  $\mu$ R series of industrial recorders. Over 800 thousand channels of this technology have performed successfully in various field and laboratory applications, thus verifying the reliability of the relay device.

A new surface-mounted version of this highly reliable SSR is used in the DARWIN family.

This permits a high degree of miniaturization, low power consumption, long device life and quiet operation.

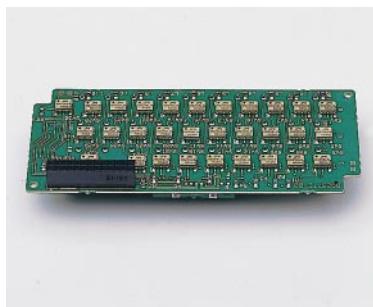

## Planar transformer

A planar transformer is a revolutionary integrated transformer which takes the place of the conventional wire-wound transformer, the most antiquated of all electronic components. This small, thin transformer consists of multi-layer precision thin film coils, enhancing insulation, and also reducing heat and noise emission. This concept design means that the power supply unit occupies just 1/2 to 1/4 of the volume of conventional units.

All of the transformers in the main unit, subunits and input and output modules of the DR240 are planar transformers. This is an important factor in achieving the large degree of miniaturization and weight reduction of the DR240.

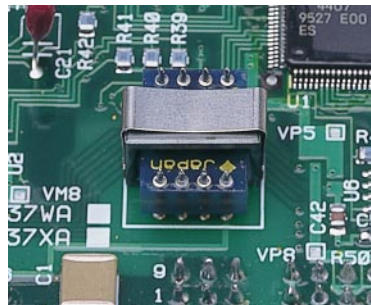

## Adoption of ASICs

The DR240 uses ASICs (Application Specific Integrated Circuit) which were developed with more than 40 years of data acquisition know-how accumulated by YOKOGAWA. Moreover, a high degree of integration has been attained by gate arrays, used around the A/D converter, communication interface, recording and display control circuits. As a result of this high degree of integration, the DR240 has become smaller and lighter, and power consumption and heat generation reduced, improving the reliability of the overall system.

## Advanced carriage drive

The carriage drive section of the dot printer head employs a screw shaft which is unique for a strip chart recorder. The drive belt and wire cable have been removed, resulting in increased reliability.



## Integration of the design, manufacture and quality evaluation system

Routine installation work is automated, preventing careless mistakes during the production process from assembly through inspection. The result is a high grade, highly reliable product. We also use precision test equipment on the production line to further increase reliability.

## Safety, EMI and EMC standards, conformity to the CE mark

The entire DARWIN family based on the safety standards of North America. DARWIN components are also based on the CE mark, which certifies conformity to European safety standards and electromagnetic interference standards.

### Safety standards:

CSA C22.2 No.1010.1-92,  
IEC1010-1:1995,  
EN61010

### EMI standard:

EN55011:1991, Group1 class A

### EMC standard:

EN50082-2:1995.



# Specifications

## DR240 Main Unit

- Stand-alone model (DR241) or Expandable model (DR242)

## DR240 Subunit

- DS400 or DS600

### General Specifications

- External Dimensions; Weight (with I/O module installed)
  - DR241: approximately 444 (W)×288 (H)×343 (D) mm; approximately 16 kg
  - DR242: approximately 444 (W)×288 (H)×308 (D) mm; approximately 12 kg
  - DS400: approximately 336 (W)×165 (H)×100 (D) mm; approximately 2.5 kg
  - DS600: approximately 422 (W)×176 (H)×100 (D) mm; approximately 3.5 kg
- AC Power Supply
  - Rated supply voltage: 100 to 240 VAC
  - Usable supply voltage: 90 to 250 VAC
  - Rated supply frequency: 50/60 Hz
  - DC power supply (Runs on a DC power supply only. Specify when ordering.)
    - Rated supply voltage: 12 to 28 VDC
    - Usable supply voltage: 10 to 32 VDC
    - Terminal: Screw terminals
- Insulation Resistance
  - At least 20 MΩ at 500 VDC between the power supply and ground, between each terminal and the ground, and between input terminals
- Withstanding Voltage
  - Between power supply terminal and ground: 1,500 VAC (50/60 Hz, 1 min.)
  - Between input/output terminal and ground: 1,500 VAC (50/60 Hz, 1 min.)
- Normal Operating Conditions
  - Supply frequency: 50 Hz ±2% or 60 Hz ±2%
  - Ambient temperature: DR241, DR242 0 to 50°C (FD operation 5 to 40°C)
  - DS400, DS600 Panel mount -10 to 60°C
  - Desk-top -10 to 50°C
- Ambient humidity: 20 to 80% RH (between -10 and 40°C)
- Safety Standards
  - CSA C22.2 No.1010.1-92, IEC1010-1:1995, EN61010
- EMI Standard
  - EN55011:1991, Group 1 class A
- EMC Standard
  - EN50082-2:1995

### System Configuration

- Configuration Method
  - DR241: Configure a system with this model by specifying necessary options, such as the input and communications functions, according to the model code when ordering.
  - DR242: Configure a system with this model by combining one or more of the modules and subunits listed below.

### Connecting Modules and Subunits (DR242)

- Standard Modules and Software for System Configuration
  - The following modules and software can be installed in a main unit and subunit to configure a data acquisition system.
- Input Modules: Universal (DCV, TC, RTD and DI), DCV/TC/DI dedicated, power monitor, strain, pulse, direct current (mA) and digital input modules
  - Connectable to DS400 and DS600
- Communications Modules: Ethernet, GP-IB, RS-232C and RS-422A/485
  - Connectable to DR242 main unit
- Alarm Contact Output Modules: 4 contacts (SPDT: NO-C-NC) and 10 contacts (make contact: NO-C).
  - Connectable to DR242 main unit or DS400 and DS600
- DI/DO Modules: Two alarm output contacts (NO-C-NC) and fail output
  - Connectable to DR242 main unit or DS400 and DS600
  - Up to 1 module/1 system can be connected.
- Extension Modules: Interfaces for remote power supply
  - One extension module can be connected to each DS400 and DS600.
  - (should be used with extension base units)
- Software: DAQ32 (Standard software)
  - DAQ32 plus (Optional software)
- Types and Number of Modules That Can Be Connected
  - DR241: Specify the types of modules and the number according to the model code.
  - DR242: Communications module DI/DO module or alarm contact output module
  - DS400/600 Input module, alarm contact output modules, DI/DO modules and extension modules
    - Four or six modules can be connected.
- Connection of Subunits
  - DR241: Cannot be connected.
  - DR242: Up to 6 subunits can be connected. One subunit can be installed on the rear panel by screws.

### Input Section

- Number of Input Channels
    - DR241: 10 to 30 channels (Specify the number of channels when ordering)
    - DR242: Power monitor input option: 2 or 6 channels
    - 0 channel. Expandable up to 300 channels by connecting subunits.
  - Types of Input Modules
    - DR241: Universal (DC voltage, thermocouple, RTD and contact), DCV/TC/DI dedicated (Specify the types when ordering), power monitor option
    - DR242: Universal (DC voltage, thermocouple, RTD and contact), DCV/TC/DI dedicated, power monitor, strain, pulse, direct current (mA) and digital input modules
  - Measurement Range: See the specifications for each input module.
  - Measurement Interval:
    - DR241: 0.5, 1, 2, 3, 4, 5, 6, 10, 12, 15, 20, 30 and 60 seconds
    - DR242: Maximum of 2 s per 30 channels
    - Maximum of 500 ms per 300 channels (including the subunit)
- The measurement interval is dependent on the slowest input module if input modules of different measurement intervals are connected at the same time.
- A/D Integration Period
    - Manual selection or automatic switchover between 20 ms (50 Hz), 16.7 ms (60

Hz) and 100 ms (10 Hz)

Minimum measurement interval when the 100-ms integration mode becomes:

- DR241: 30 channels; 6 seconds
- DR242: 4 seconds per 300 channels (including the subunit) (depends on the modules and number of channels)

### Recording section (DR241/242 main unit)

- Recording Method
  - Raster scan method, 10-color wire dot recording
- Number of Recording Points
  - 300 points maximum (stand-alone model: 30 points + AC 6 points)
- Recording Paper
  - Effective recording width: 250 mm (for analog trend measurement)
  - Analog recording color (You can specify a color for each channel.) Purple, red, green, blue, brown, black, navy blue, yellow-green, red-purple, orange
  - Analog Recording Interval
    - FIX: Recording takes place at the specified measurement interval between 2 and 60 seconds (not all measured values are sampled for analog recording in case of the 0.5- and 1-second measurement intervals)
    - AUTO: Linked to recording paper feed speed
- Recording Paper Feed
  - Paper feed speed: 1 to 1,500 mm/hour

### Display Section

- Display Section
  - Display: VFD display (5 x 7 dot matrix, 3 lines)
  - Number of characters: 22 characters (large/1 line), 40 characters (2 lines)

### Memory Function Section

- Memory Media
  - 3.5-inch floppy disk drive with 512 kB SRAM buffer memory
- Data Capacity
  - 10 data/ch to 50 kdata/ch
  - (Total data memory should be less than total memory length.)
- Applicable data
  - Setting values, measurement values and computed values except report calculating values
- Memory Mode
  - Binary
  - Can be converted to ASCII (CSV) format for copying buffer memory data to floppy disk
- Sample Rate
  - Synchronized with the measurement interval of the recorder unit, or synchronized with event.

### Alarms

- Number of Settings
  - Up to four settings can be made for each channel.
- Kinds of Alarms
  - Upper/lower limit, difference upper/lower limit, upper/lower limit of percentage change, upper or lower limit only for the results of computation
  - Percentage change alarm time interval: 1 to 15 scans
- Number of Alarm Output Points
  - DR241: 12 maximum (alarm option: 10; DI/DO option: 2)
  - DR242: 300 in total

### Standard Computation Functions

- Kinds of Computation
  - Difference between arbitrarily selected channels, linear scaling, moving average, pulse integration
- Scalable range: DC voltage, thermocouple, RTD, contact
- Scaling range: -30,000 to +30,000
- Moving average: 2 to 64 scans
- Pulse integration: Effective when a pulse input module is recognized (up to 60 channels)

### Fail, Chart End Output

- (DR expandable model. The DR stand-alone model uses the /R1 option.)
- Functions: Refer to the DI / DO modules.

## Optional Specifications

### Computation Function (/M1)

- Number of Computation Channels
  - DR241: 30 channels maximum
  - DR242: 60 channels maximum
- Kinds
  - Remote RJC, four arithmetic operations, SQR (square root), ABS (absolute value), LOG (common or natural logarithm), EXP (exponential), statistics processing (CLOG, TLOG), logic (AND, OR, NOT, XOR), relative computation, previous data reference.
- CLOG: Mathematical processing within a group of data that was measured at the same time (total, maximum, minimum, average, max. - min.)
- TLOG: Mathematical processing of data from a certain channel over a period of time (24 hours maximum) (total, maximum, minimum, average max. - min.)

### Report Function (/M3)

- Instantaneous values of measured data, as well as maximum, minimum, average and total, for each hour, day or month are printed in tabular form on recording paper. Analog recording is interrupted while a report is being made.
- Report calculation channels: Up to 60 channels
- Note: This function does not allow the results of the report and computing function to be saved on floppy disks. (Thus, to be able to transfer the results to a personal computer, the DP380 report software is needed. Note that the DP380 software cannot be run simultaneously with the DAQ32 or DAQ32Plus software package.)

### Power Monitor Options (/N7, /N8)

- Applicable models and outline specifications
  - DR241 stand-alone model (For the DR242, the power monitor module is sold separately.) Refer to the power monitor module.

### GP-IB Communications Option (/C1)

- Applicable models and outline specifications
  - DR241 stand-alone model (For the DR242, the GP-IB module is sold separately.) Refer to the GP-IB module.

**RS-232C communications option (C2)**

● Applicable models and outline specifications  
DR241 stand-alone model (For the DR242, the RS-232C module is sold separately.) Refer to the RS-232C module.

**RS-422A/485 communications options (C3S)**

● Applicable models and outline specifications  
DR241 stand-alone model (For the DR242, the RS-422-A/485 modules are sold separately.)  
Refer to the RS-422A/485 module.

**Ethernet communication option (C7)**

● Applicable models and outline specifications  
DR241 stand-alone model (For the DR242, the Ethernet module is sold separately.) Refer to the Ethernet module.

**Alarm Contact Output Option (A4)**

● Applicable Models and outline specifications  
DR241 stand-alone model (For the DR242, the alarm contact output module is sold separately.)  
Refer to the alarm output module.

**Recorder Function Remote Control Option (R1)**

● Applicable models and outline specifications  
DR241 stand-alone model (For the DR242, the DI/DO module is sold separately.)  
The DR242 expandable model incorporates fail and chart-end outputs as standard features.  
Refer to the DI/DO module.

**Input Module**

**Specifications Common to Input Module**

● Normal Operating Temperature/Humidity Range  
Universal, DCV/TC/DI input module:  
-10 to 60°C, 20 to 80% RH (non condensing)  
mA, power monitor, strain, except DU500-14 pulse input module:  
0 to 50°C, 20 to 80% RH (non condensing)

● Withstanding Voltage  
Between input terminals:  
1,000 VAC (50/60 Hz) for one minute  
Strain input: 50 VDC (50/60 Hz, 1 minute except DU500-14)  
Between input terminal and ground:  
1,500 VAC (50/60 Hz) for one minute

**Universal Input Modules**

**DCV/TC/DI Input Modules**

Module	Model	Number of Channels	Type of Terminal	Measurement Interval
Universal input	DU100-11	10	Screw	0.5 s
	DU100-12	10	Clamp	0.5 s
	DU100-21	20	Screw	2 s
	DU100-22	20	Clamp	2 s
	DU100-31	30	Screw	2 s
	DU100-32	30	Clamp	2 s
DCV/TC/DI input	DU200-11	10	Screw	0.5 s
	DU200-12	10	Clamp	0.5 s
	DU200-21	20	Screw	2 s
	DU200-22	20	Clamp	2 s
	DU200-31	30	Screw	2 s
	DU200-32	30	Clamp	2 s

● General Specifications  
Input method: Floating imbalance input, and inter-channel isolation  
RTD and pulse inputs are of the same potential within the same input module.  
A/D resolution: ±20,000  
A/D integration time: Manual selection or automatic switchover between 20 ms (50 Hz), 16.7 ms (60 Hz) and 100 ms (10 Hz)  
Measurement Range  
DC voltage range: 20 mV to 50 V  
Thermocouple: R, S, B, K, E, J, T, L, U, N, W, KP-Au7Fe  
RTD: Pt100, JPt100, Ni100, Ni120, Cu10, and J263\*B  
Contact input: Voltage-free contact input or voltage input  
Mixed input is allowed for DC voltage, thermocouple, RTD and contact inputs. (For an DCV/TC/DI input module, RTD input is not allowed.)  
Measurement accuracy: ±(0.05% of reading + 2 digits)  
(at 2-V range, 23 ±2°C and 55 ±10% RH)  
Noise rejection: By means of integrating A/D, low-pass filter or moving average  
Burnout: Detected within thermocouple-input range

**DC Current Input Modules**

Model	Number of channels	Type of Terminals	Measuring Interval
DU300-11	10	Screw	0.5 s
DU300-12	10	Clamp	0.5 s

● General Specifications  
Input method: Floating imbalance input, and inter-channel isolation  
Shunt resistor (100 Ω) is pre-installed.  
A/D resolution: ±20,000  
A/D integration time: Manual selection or automatic switchover between 20 ms (50 Hz), 16.7 ms (60 Hz) and 100 ms (10 Hz)  
Measurement range (resolution): ±20 mA (1μA)  
Noise rejection: By means of integrating A/D, low-pass filter or moving average

**Power Monitor Modules**

Model	Number of Channels	Type of Terminal	Measurement Interval
DU400-12	For single phase: one for voltage and one for current	Clamp	2 s
DU400-22	For 3 phases: three for voltage and three for current	Clamp	2 s

Input method: Transformer isolation  
Measured variables: Six items can be selected from the the following:  
RMS value of AC voltage/current, active power, apparent power, reactive power, frequency, power factor and phase angle (There is a restriction in combining selected items.)  
Measurement range (resolution):  
Voltage: 250 V (0.1 Vrms), 25 V (0.01 Vrms)  
Current: 5 A (0.001 Arms), 0.5 A (0.0001 Arms)

Measurement accuracy: ±(0.5% of span when RMSV and A are measured)  
Measured frequency: 45 to 65 Hz (all channels must have the same frequency)  
Crest factor: Up to 3  
Power integration: Calculated by M1 (computation function) option.  
/M1 must be specified for the DR240.

**Strain Measurement Modules**

Model	Number of Channels	Type of Terminal	Measurement Interval
DU500-12	10*, with built-in 120 Ω resistance	Clamp	0.5 s
DU500-13	10*, with built-in 350 Ω resistance	Clamp	0.5 s
DU500-14	10*, for external bridge box	NDIS	0.5 s

\*: 2 modules' width is required.

● General Specifications  
Measurement range (resolution):  
2,000 με (0.1 με)  
20,000 με (1 με)  
200,000 με (10 με)  
Built-in bridge resistance: 120 Ω, 350 Ω, or none (for an external bridge box)  
Wiring: 1/4 bridge 1/2 bridge (neighbor), 1/2 bridge (opposite), full bridge  
Applicable gauge resistance: 1/4 or 1/2 bridge: 120 or 350 Ω  
Full bridge: 100 to 1,000 Ω  
Bridge voltage: Fixed at 2 V  
Gauge factor: 2.00 (with scaling function)  
Strain balance: Electronic auto-balancing (can be turned on or off in each module) within ±10,000 με (1/4bridge)

**Pulse Measurement Modules**

Model	Number of Channels	Type of Terminal	Measurement Interval
DU600-11	10	Screw	0.5 s*

\*: Rate of data update is fixed at one-second interval.

● General Specifications  
Input method: Shared common line within the same module  
Type of input: Non-voltage contact or open collector (TTL or transistor)  
Measurement modes  
RATE (count value instantaneous mode):  
The number of pulses input during the most recent one-second period of measurement is output as the scale set value.  
GATE (ON time instantaneous mode):  
The ON (make)/OFF (break) state (ON = 1, OFF = 0) of the contact input during the most recent one-second period of measurement is output as the scale set value.  
Pulse integration: The computation function is used when integrating either the count value each second or the ON period.  
Computation formula: TLOG.PSUM (XXX)  
Number of computation channels: Max. 60 channels  
Max. count value/ON period:  
99999999  
(/M1 (computation option) need not be specified for the DA100 or DR recorder main unit. Pulse integration can be used automatically when a pulse module is recognized.)  
Maximum input frequency: 6 kP/s (10 P/s for voltage-free contact)  
Filter: For rejection of chattering up to 5 ms (can be turned on and off for every channel)

**Digital Input Module**

Model	Number of Channels	Type of Terminals	Measurement Interval
DU700-11	10	Screw	0.5 s

● General Specifications  
Input method: Unbalanced floating-point, with channel-to-channel isolation (individually separated channels)  
Measuring range: Voltage input 2.3 V or less ..... 0  
2.5 V or greater ..... 1  
Voltage-free contact input Off (open) ..... 0  
On (closed) ..... 1  
Maximum input voltage range: Voltage input ±60 V DC  
Voltage-free contact input ±10 V DC

**Alarm, DI/DO and Other Modules**

**Alarm Contact Output Modules**

Model	Number of Outputs	Contact Arrangement	Type of Terminal
DT200-11	4	SPDT (NO-C-NC)	Screw
DT200-21	10	Make contact (NO-C)	Screw

● General Specifications  
Output mode: Selection between excitation and non-excitation, output hold and non-hold and AND and OR modes  
Re-breakdown re-alarm: Maximum of 6 contacts can be selected.  
Contact capacity: 250 VDC/0.1 A (resistive load)  
30 VDC/2 A (resistive load)  
250 VAC/2 A (resistive load)

**DI/DO Modules**

● Common Specifications  
Model: DT100-11  
The DR242 expandable model incorporates fail and chart-end output as standard features. (Up to 1 module can be connected to the DR240 expandable model.)

● Alarm Contact Output

Number of outputs: 2  
Contact mode: SPDT—NO-C-NC terminal  
Contact capacity: 250 VDC/0.1 A (resistive load)  
30 VDC/2 A (resistive load)  
250 VAC/2 A (resistive load)

● Chart End Output

Outline of functions: The chart end output terminal is energized if the recording paper in the recorder breaks.  
The DR stand-alone model uses the /R1 option.  
Contact mode: Make contact (NO-C). Cannot be switched between excited and non-excited.  
Contact capacity: 250 VDC/0.1 A (resistive load)  
30 VDC/2 A (resistive load)  
250 VAC/2 A (resistive load)



- **Fail Output**  
Function: If an abnormality is found in the total system, the fail output terminal is de-energized.  
Output mode: Make contact (NO-C). Cannot be switched between excited and non-excited.  
Contact capacity: 250 VDC/0.1 A (resistive load)  
30 VDC/2 A (resistive load)  
250 VAC/2 A (resistive load)

- **Remote Control Signal Input**  
Function: Start and stop recording  
Change chart speed  
Start message printing  
Start and stop memory sampling  
Control statistical calculation interval  
Input signal: Non-voltage contact or open collector (TTL or transistor)

#### Extension Modules

- Unit to connect with: DS400 or DS600 subunit (one for each subunit)
- Number of input modules: One input module can be mounted on an extension base unit. Up to 3 extension base units can be connected to one extension module in series.

- Type of input modules: 10-ch universal input module

- Extensible distance: 10-ch DCV/TC/DI input module  
Up to total length of 30 m

#### Communications Modules

##### Specifications Common to Communications Modules

###### ● Functions, Common Specifications

- Outline of functions: Output of measured values, output of set points, setup of measurement conditions, control of start/stop of measurement, etc.

- Withstanding voltage: 1,500 VAC (50/60 Hz) for one minute between output terminal and ground

#### GP-IB Modules

- Electrical and mechanical specifications: Based on IEEE standard 488-1978
- Addresses: 0 to 15

#### RS-232C Modules

- Electrical and mechanical specifications: Based on EIA RS-232C
- Communications format: Half duplex
- Synchronization: Start-stop synchronization (synchronization by means of the start and stop bits)
- Baud rate: 150, 300, 600, 1200, 2400, 4800, 9600, 19200 or 38400 bps
- Transmission distance: Maximum of 15 m
- Connector: D-sub 25-pin connector

#### RS-422A/485 Modules

- Electrical and mechanical specifications: Based on EIA RS-422A and EIA RS-485
- Connection method: Multi-drop
- Address: 1 to 31
- Communications format: Half-duplex, 4-wire method/2-wire method
- Synchronization: Start-stop synchronization (synchronization by means of start and stop bits)
- Baud rate: 300, 600, 1200, 2400, 4800, 9600, 19200 or 38400 bps
- Transmission distance: Maximum of 1200 m
- Connector: 6-screw terminal

#### Ethernet Modules

- Network configuration: Ethernet (10Base-T)
- 10Base-T modular connector: 1
- Baud rate: 10 Mbps
- Communication protocol: TCP, UDP, IP, ARP or ICMP
- Input data: ASCII
- Output data: ASCII or binary

## ■ Model and Suffix Codes

### DR240 Stand-alone model

Model	Suffix code	Description	
DR241		Panel mount type hybrid recorder	
Memory	-0	No memory	
	-1	3.5-inch FD	
Software	0	No DAQ32 software	
	2	DAQ32 software included	
Input channel	-1	10 ch	
	-2	20 ch	
	-3	30 ch	
Input	1	Universal input, screw	
	2	Universal input, clamp	
	3	DCV/TC/DI input screw	
	4	DCV/TC/DI input clamp	
Power supply voltage	-1	100 to 240 VAC	
	-2	12 to 28 VDC (DC power supply only)	
Power inlet, power cable	W	Screw terminal	
	Y	Screw terminal for DC power supply (w/o power cord)	
Additional specifications	/M1	Computing functions	
	/M3	Report function	
	/C1	GP-IB	
	/C2	RS-232C	
	/C3S	RS-422/485 (screw)	Must not coexist
	/C7	Ethernet	
	/N7	Power monitor for single phase	
	/N8	Power monitor for 3 phase	Must not coexist
	/A4	Alarm output module (A type 10 contacts)	
	/R1	2-point alarm output, remote control signal input, fail output, and chart end output	
/H1	Internal illumination		
/D2	*F display		

- The maximum allowable number for the / N□ / C□ / A4 and / R1 options is determined according to the specified channel number.  
10 ch: All options can be specified.  
20 ch: All of them can be specified.  
30 ch: 3 of them can be specified.
- When "-0" of the memory code is selected, "0" of the software code must be always specified.  
No data conversion software is provided with the unit.

### DR240 Expandable model

Model	Suffix codes	Description
DR242		Panel mount type hybrid recorder
Memory	-0	No memory
	-1	3.5-inch FD
Data conversion	0	No DAQ32 software
	2	DAQ32 software included
Input	-00	Always -00
Power supply voltage	-1	100 to 240 VAC
Power inlet, power cable	W	Screw terminal
Additional specifications	/M1	Computing functions
	/M3	Report function
	/H1	Internal illumination
	/D2	*F display

- Subunits and input/output modules must be ordered separately from the main unit.
- The extension cable must be ordered separately when the subunit is specified.

### Subunit: DS400, DS600

Model	Suffix codes	Description
DS400		4-module connection type subunit
DS600		6-module connection type subunit
Type	-00	Always -00
Power supply voltage	-1	100 to 240 VAC
Power inlet, power cable	D	3-pin power inlet w/UL, CSA cable
	F	3-pin power inlet w/VDE, cable
	R	3-pin power inlet w/SAA, cable
	S	3-pin power inlet w/BS, cable
	W	With 3-pin inlet screw conversion terminal

### Configuration example of the expandable model

- 100 ch, 0.5 s universal input, with RS-232C and 20-ch alarm output
- DR240 expandable main-unit: DR242 × 1
- Sub unit: DS600 × 2
- Universal input module: DU100-11 or -12 × 10
- Communication module: DT300-21 (RS-232C) × 1
- Alarm output module: DT200-21 × 2
- Extension cable × 2

## Input modules

Model	Description	Required slots	Terminal profile	Max. measuring period
DU100-11	10-channel universal input (DCV, TC, DI & RTD)	1	Screw	0.5 s
DU100-21	20-channel universal input (DCV, TC, DI & RTD)	2	Screw	2 s
DU100-31	30-channel universal input (DCV, TC, DI & RTD)	3	Screw	2 s
DU100-12	10-channel universal input (DCV, TC, DI & RTD)	1	Clamp	0.5 s
DU100-22	20-channel universal input (DCV, TC, DI & RTD)	2	Clamp	2 s
DU100-32	30-channel universal input (DCV, TC, DI & RTD)	3	Clamp	2 s
DU200-11	10-channel DCV/TC/DI input	1	Screw	0.5 s
DU200-21	20-channel DCV/TC/DI input	2	Screw	2 s
DU200-31	30-channel DCV/TC/DI input	3	Screw	2 s
DU200-12	10-channel DCV/TC/DI input	1	Clamp	0.5 s
DU200-22	20-channel DCV/TC/DI input	2	Clamp	2 s
DU200-32	30-channel DCV/TC/DI input	3	Clamp	2 s
DU300-11	10-channel mA input module	1	Screw	0.5 s
DU300-12	10-channel mA input module	1	Clamp	0.5 s
DU400-12	Power monitor module for single phase	1	Clamp	2 s
DU400-22	Power monitor module for 3 phase	1	Clamp	2 s
DU500-12	10-channel strain input module (120 Ω)	2	Clamp	0.5 s
DU500-13	10-channel strain input module (350 Ω)	2	Clamp	0.5 s
DU500-14	10-channel strain input module (External bridge box)	2	NDIS	0.5 s
DU600-11	10-channel pulse input	1	NDIS	0.5 s
DU700-11	Digital input	1	Screw	0.5 s

## I/O terminal module

Model	Description
DT100-11	DI/DO module (2-point alarm output, remote control signal input, fail/chart end output)
DT200-11	Alarm output module (4 transfer contacts)
DT200-21	Alarm output module (10 make contacts)
DT300-11	GP-IB module
DT300-21	RS-232C module
DT300-31	RS-422/485 module
DT300-41	Ethernet module

## Optional accessories

Model	Description
DV100-011	Extension module
DV100-012	Extension base unit
DV200-000	Extension cable (0.5 m)
DV200-001	Extension cable (1 m)
DV200-002	Extension cable (2 m)
DV200-005	Extension cable (5 m)
DV200-010	Extension cable (10 m)
DV200-020	Extension cable (20 m)
DV200-050	Extension cable (50 m)
DV200-100	Extension cable (100 m)
DV200-200	Extension cable (200 m)
DV200-300	Extension cable (300 m)
DV200-400	Extension cable (400 m)
DV200-500	Extension cable (500 m)
DV250-001	Cable adapter
DV300-011	Shunt resistor 10 Ω, for screw
DV300-012	Shunt resistor 10 Ω, for clamp
DV300-101	Shunt resistor 100 Ω, for screw
DV300-102	Shunt resistor 100 Ω, for clamp
DV300-251	Shunt resistor 250 Ω, for screw
DV300-252	Shunt resistor 250 Ω, for clamp
DV400-011	Rack mounting kit (DS400/600)
DV400-051	Power cable between DR expandable main unit and subunit
DV450-001	Strain converter

## Software

Model	Description	Applicable Operating System
DP120-13	DARWIN DAC32 software (Supports setup, simplified data logging and viewing, and diagnosis and calibration functions. One package of this software comes standard with the purchased DR240 recorder if you specify the model code specification for "software included.")	Windows 95, Windows 98 or Windows NT4.0
DP320-13	DARWIN DAC32Plus software (Supports setup, data logging and viewing, diagnosis and calibration and tag setting functions.)	Windows 95, Windows 98 or Windows NT4.0
DP350-13	Enhanced multifunctional data logging software	Windows 3.1, Windows 95 or Windows 98
DP380-13	Report software	Windows 3.1, Windows 95 or Windows 98
DP800-□E	"InTouch for DARWIN" data logging software for process use (Choices for the # field: 1 = 40 channels; 2 = 120 channels; 3 = 300 channels)	Windows 95 or Windows NT4.0

The DP120 (DAC32) and DP320 (DAC32Plus) data acquisition software cannot be run simultaneously, and neither can the combination of the DP350 enhanced multi-functional data logging software, DP380 report software and DP800 InTouch for DARWIN software.

## Spares

Part No.	Name	Order qty
B9627AZ	10-color ribbon	1
B9627RY	Z-fold paper (30 m) (time axis:10 mm)	10
B9627AY	Z-fold paper (30 m) (time axis:25 mm)	10

● Standard accessories for the DR240

One Z-fold chart paper, one ink ribbon, one pair of panel mounting brackets, instruction manuals.

## External Dimensions (DR242 with DS600 subunit on the rear panel)

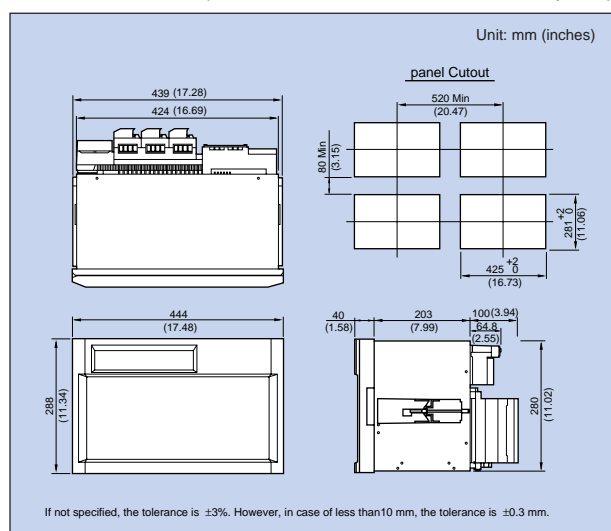

Excal, Windows, MS and MS-DOS are registered trademarks of Microsoft Corporation, USA.  
 IBM and IBM PC/AT are registered trademarks of International Business Machines Corp.  
 Lotus 1-2-3 is a registered trademark of Lotus Development Corporation.  
 AT-GPIB and GPIB-98 Turbo are registered trademarks of National Instruments.  
 Ethernet is a registered trademark of Xerox Corporation.  
 Other company and/or product names are registered trademarks of the respective companies.

# YOKOGAWA

## YOKOGAWA CORPORATION OF AMERICA

2 Dart Road, Newnan, Georgia 30265, U.S.A.  
 Phone: 770-253-7000, Fax: 770-251-2088

## YOKOGAWA EUROPE B.V.

Vanadiumweg 11, 3812 PX Amersfoort, THE NETHERLANDS  
 Phone: 31-33-4-641611, Fax: 31-33-4-631202

## YOKOGAWA ENGINEERING ASIA PTE. LTD.

11 Tampines Street 92, Singapore 1852, SINGAPORE  
 Phone: 65-783-9537, Fax: 65-786-6650

## YOKOGAWA ELECTRIC CORPORATION

Test & Measurement Business Division  
 155 Takamuro-cho, Kofu-shi, Yamanashi-ken, 400-8558 Japan  
 Phone: 81-552-43-0309, Fax: 81-552-43-0396

Represented by :

DRM-06E