

DIGITAL INDICATING CONTROLLER

LT350 Series



LT350 series, 1/8 DIN size, new digital indicating controllers feature all functions including newly developed PID algorithms and overshoot suppression function which are convenient in various control applications.

MODEL

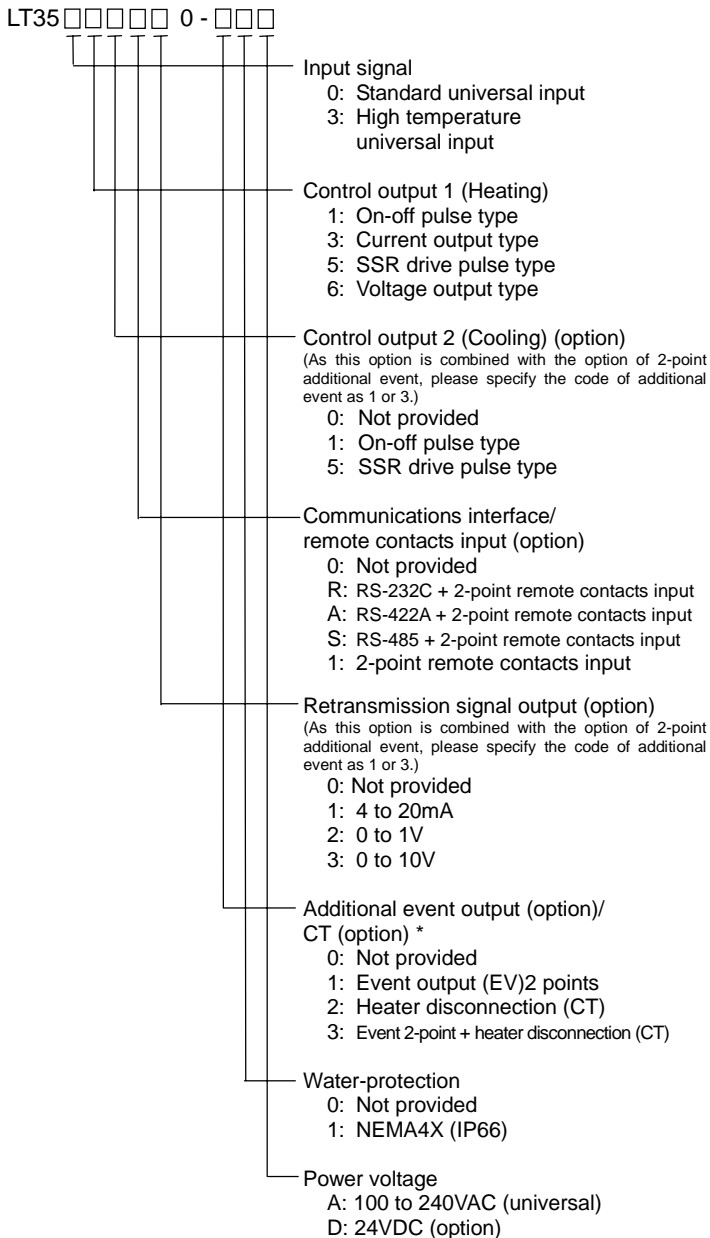

* The heater disconnection (CT) is only applied to the Control output 1 of on-off pulse type or SSR drive pulse type.

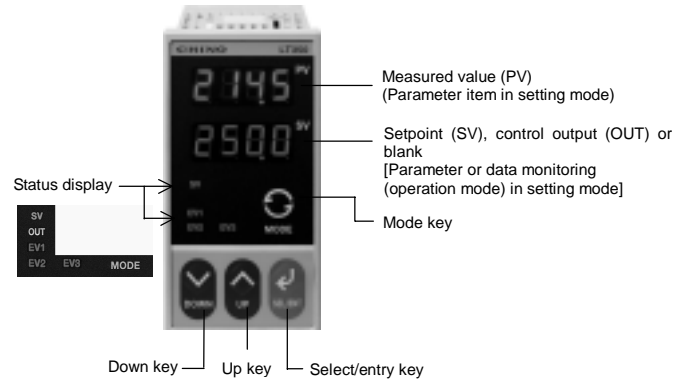

FEATURES

- Large size 4-digit LED display
- Universal input
- New PID algorithms built-in
- New overshoot suppression function built-in
- MODBUS protocol communications for easy system configuration
- Various functions are built-in for easy control.
- Only 7mm thickness of the front panel
- Conformance to CE, UL and CSA (UL, CSA: Approval pending)
- Water and dust protection conforming to NEMA250 4X (IEC529 IP66) (option)

MEASURING RANGES

Input type		Input range		Standard universal	High temp. universal
T/C	B	0.0 to 1820°C	32 to 3300°F		
	R	0.0 to 1760°C	32 to 3200°F		
	S	0.0 to 1760°C	32 to 3200°F		
	N	0.0 to 1300°C	32 to 2350°F		
	K	-200 to 1370°C	-300 to 2450°F		
	E	-199.9 to 700.0°C	-300 to 1250°F		-
	J	-199.9 to 900.0°C	-300 to 1650°F		-
	T	-199.9 to 400.0°C	-300 to 700°F		-
	U	-199.9 to 400.0°C	-300 to 700°F		-
	L	-199.9 to 900.0°C	-300 to 1650°F		-
	WRe5-WRe26	0 to 2310°C	32 to 4190°F	-	
	W-WRe26	0 to 2310°C	32 to 4190°F	-	
	PtRh40-PtRh40	0 to 1880°C	32 to 3400°F	-	
Platinel II	0 to 1390°C	32 to 2500°F	-		
RTD	Pt100	-199.9 to 850.0°C	-300 to 1500°F		
	JPt100	-199.9 to 649.0°C	-300 to 1200°F		
DC voltage	5V	0 to 5V (0.000 to 5.000)	Scaling setting range: -19999 to 20000 Decimal place can be adjusted.		
		4 to 20mA (1.000 to 5.000 - Converted into voltage value)			
DC current	20mA *				

Note: For the current input, a 250Ω shunt resistor (sold separately) is required. The ranges marked with - are built in.

■ SPECIFICATIONS

INPUT SPECIFICATIONS

Input signal:

Thermocouple ... B, R, S, N, K, E, J, T, U, L
Resistance thermometer ... Pt100, JPt100
DC voltage ... 0 to 5V
DC current ... 4 to 20mA [By using a 250Ω shunt resistor (sold separately) and 5V range (1 to 5V)]

Measuring range:

Refer to the list of measuring ranges.
Total of 14 kinds consisted of 10 kinds of thermocouple, 2 kinds of resistance thermometer, 1 kind of dc voltage, and 1 kind of dc current

Accuracy ratings:

±0.25% of measuring range ± 1 digit (at reference operation conditions)

Refer to the details of accuracy ratings.

Reference junction compensation accuracy:

±1.0°C (23°C ± 10°C), ±2.0°C (-10 to 50°C)

Temperature unit: °C or °F

Sampling period: Approx. 0.5 second

Burnout:

Up scale (thermocouple input/resistance thermometer input)

Allowable signal source resistance:

Thermocouple/mV input ... 250Ω or less
V input ... 1kΩ or less
Resistance thermometer input ... 10Ω or less (per wire)

Input resistance: Thermocouple/DC voltage ... 1MΩ or more DC current ... Approx. 250Ω

Measuring current: Resistance thermometer ... Approx. 110μA

Measuring input shift (sensor correction):

Can be set by the resolution being 0.1 times the setting resolution of SV (-1999 to 9999)

Digital filter: 0.0 to 99.9 seconds

Scaling: Range/scale of DC voltage/current input (-1999 to 9999), optional setting

Scale decimal point: 0 to 3

Maximum allowable input range: DC voltage ... ±10VDC RTD ... ±5VDC

Maximum common mode voltage: 30VAC

Common mode rejection ratio:

130dB or more (50/60Hz) (signal source resistance 1Ω or less)

Series mode rejection ratio:

50dB or more (50/60Hz) (signal source resistance 1Ω or less)

CONTROL SPECIFICATIONS

Control cycle time: Approx. 0.5 second

Control system:

On-off pulse type PID system
Current output type PID system
SSR drive pulse type PID system
Voltage output type PID system
* 2-position control can be selected.

Control setpoint: 2 sets switching, 4-digit setting

Setpoint limiter: Within measuring range

Setpoint ramp function:

Setpoint ramp unit ... °C/minute (common to rising/falling)
Setpoint rising ramp: 0 to 9999 (0 = no operation)
Setpoint falling ramp: 0 to 9999 (0 = no operation)
PV start function ... At SV change, power-on, Run/Ready

Control setpoint accuracy ratings:

Relative error to displayed value ... ± 1 digit

Auto-tuning: Standard (Manual setting of PID constants possible)

PID constants:

P ... 0.1 (0.0) to 999.9% (0 = 2-position)
I ... 0 to 9999 seconds
D ... 0 to 9999 seconds

PID deadband (gap):

0.0 to 9.9%

Anti-reset windup:

High limit ... 0.0 to 100.0%, Low limit ... -100.0 to 0.0%

Overshoot suppression function:

ON/OFF selectable

Control operation:

With direct/reverse action switching

Output specifications:

● On-off pulse type

Output signal ... On-off pulse conductive signal
Contact ratings ...
Resistive load 100VAC 5A, 240VAC 5A, 30VDC 5A
Inductive load 100VAC 2.5A, 240VAC 2.5A, 30VDC 2.5A

Electrical relay life ... More than 100,000 times
Pulse cycle ... Approx. 1 second to 180 seconds adjustable
Contact protection element ... Not built-in [If required, add a contact protection element (sold separately) externally.]

● Current output type

Output signal ... 4 to 20mADC, Load resistance ... 600Ω or less,

● SSR drive pulse type

Output signal ... On-off pulse voltage signal
At ON 12VDC ± 20% (load current ... 20mA or less)
At OFF 0.8VDC or less

Pulse cycle ... Approx. 1 second to 180 seconds adjustable

● Voltage output type

Output signal ... 0 to 10VDC
Output resistance ... Approx. 10Ω
Load resistance ... 50kΩ or more

Output limiter: 1 set

High limit ... 0.0 to 105.0%, Low limit ... -5.0 to 100.0%

Output variation limiter:

0.1 to 100.0%

Output preset: -100.0 to 100.0%

Run/Ready: Run/ready (control stop, output: preset output value) switching

Preset output: -5.0 to 105.0%

Control at power recovery: Continuous/ready switching

EVENT SPECIFICATIONS

Event calculation: 3 points

Event output point:

Transistor output 1 point (EV1)
[2-point relay output (EV2/EV3) can be added as an option.]

Event type:

Setting to each of Event 1/2/3
Absolute value alarm ... High/low, standby enable/disable
Deviation alarm ... High/low, standby enable/disable
Absolute value deviation alarm ... High/low, standby enable/disable
Output value alarm ... High/low, standby enable/disable
FAIL, heater disconnection alarm, timer function (EV1/EV2 only)

Event setpoint: Event 1/2/3 individual setting

Event deadband: Can be set by the resolution being 0.1 times the setting resolution of SV, Setting to each Event 1/2/3

Event output phase: Normal/reverse switching

Event output at Ready: Off/calculation switching

Event output:

Output signal ... Transistor open collector output
Contact ratings ... 24VDC or less, 50mADC or less

DISPLAY SPECIFICATIONS

Display type: 4-digit seven-segment LED display, two lines

Status display ... 5 independent LEDs

Display content:

First LED (green) display ...
At operation mode: Measured value (PV)
At setting mode: Parameter item
Second LED (red) display ...
At operation mode: Setpoint (SV) or control output value (OUT)
At setting mode: Parameter or data monitoring (operation mode)
Status (red/green) ...
EV1 (red): Lights when EV1 is activated.
EV2 (red): Lights when EV2 is activated.
EV3 (red): Lights when EV3 is activated.
SV (green): Lights when the SV is displayed in the second display.
OUT (green): Lights when the control output value is displayed in the second display.

Operation mode display:

No display function of the operation mode screen, 5 levels

Automatic return:

Returns to operation mode if any key is not pressed for more than 1 minute in setting mode.

Password: No display function of the setting mode screen by a password, 3 levels

Key lock: Locking function of parameters, 5 levels

GENERAL SPECIFICATIONS

Rated power voltage:

100 to 240VAC 50/60Hz (universal)

* 24VDC power voltage is available as an option.

Allowable power voltage: 90 to 264VAC

Power consumption: Approx. 14VA (max.)

Operation conditions:

Operation	Reference condition	Normal condition
Ambient temperature	23°C ± 2°C	-10 to 50°C (Max. 40°C for closed-installation)
Ambient humidity	55% ± 5%RH	20 to 90%RH
Power supply	100VAC ± 1%, 24VDC	90V to 264VAC, 24VDC ± 10%
Power frequency	50Hz/60Hz ± 1%	50Hz/60Hz ± 2%
Mounting angle	Forward/backward ±3 degrees or less	Forward/backward ±10 degrees or less
Vibration/impact	0m/s ² / 0m/s ²	2m/s ² / 0m/s ²

Ambient temperature change ratio: 10°C/H or less

Warm-up time: 30 minutes or more

Power interruption: Parameters are memorized by EEPROM (Writing: Approx. 1,000,000 times)

Insulation resistance:

Between primary side terminals (*1) and secondary side terminals (*2) 20MΩ or more at 500VDC

Dielectric strength:

Between primary side terminals (*1) and secondary side terminals (*2) 1 minute at 1500VAC

*1 = Terminals of power supply, control output event output

*2 = Terminals except above and DC power supply (+, -)

Front and case: Front ... Non-flammable ABS

Case ... Non-flammable polycarbonate resin

Color: Gray

Installation: Flush panel installation

Weight: Approx. 350g (max.)

Transportation/storage condition (with packing at shipment):

Ambient temperature ... -20 to 60°C

Ambient humidity ... 5 to 95%RH (no dew condensation)

Vibration ... 0 to 4.9m/s² (10 to 60Hz)

Impact ... 400m/s² or less

INTERNATIONAL STANDARDS

CE: EN61326+A1 *, EN61010+A2

UL: UL3121-1 (approval pending)

CSA (C-UL): C22.2, No. 1010 (approval pending)

NEMA: NEMA250 4X (front panel: option) (equivalent to IEC529 IP66)

Note: Not available for closed-installation

* The display of the measured value and output may vary up to ±10% or ±2mV under the EMC test ambient.

ACCURACY RATINGS

Input	Accuracy ratings	Details	
T/C	B	Not specified for less than 400°C 400°C to 800°C: ±0.5% ± 1 digit 0°C to 400°C: ±0.5% ± 1 digit 0°C to 400°C: ±0.5% ± 1 digit	
	R		
	S		
	N		
	K		
	E		
	J		
	T		
	U		
	L		
RTD	Pt100	exception: ±0.5% ± 1 digit for -200°C to 0°C	
	JPt100		
DC voltage	mV, V	±0.25% ± 1 digit	
DC current	mA	±0.25% ± 1 digit	By using the shunt resistor specified for current input

STANDARD ACCESSORIES

Mounting bracket 2 pieces, Instruction manual 1 copy

OPTIONS

Option	Contents
Communications interface (RS-232C, RS-422A or RS-485)	The setpoint and the measured value can be transmitted to a PC, and the parameters can be set by the PC. Protocol: MODBUS, RTU mode/Ascii mode switching, and private protocol Address: 01 to 99 Communications function: 1 kind to be specified from setting/data transmission, digital transmission, or digital remote * Parameters can be re-written approx. 1 million times.
Retransmission signal output	Signal in proportion to measured value or setpoint is output. Output signal: 1 kind to be specified from 4 to 20mA (load resistance ... 400Ω or less), 0 to 1VDC or 0 to 10VDC (output resistance ... approx. 10Ω, load resistance ... 50kΩ or more) Output accuracy: ±0.2% of retransmission scale range Output resolution: Approx. 1/30000 Retransmission scale: Same as measuring range
Remote contacts input	The followings can be switched by the remote contacts input. Input point: 2 points (No-voltage contacts or transistor open collector) (Remote contacts rating ... 5VDC or more, 1mA or more) Function: The following functions are allocated by parameter settings. (1) Setpoint external switching (2) Run/ready switching, (3) Timer start-up (4) Remote/local switching
Control output 2 (Heating/cooling)	Control calculation: Matching calculation/cooling proportion calculation switching Matching calculation parameters • Split direct ... 0.0 to 60.0% • Split reverse ... 40.0 to 100.0% Cooling proportion calculation parameters • Cooling proportional band coefficient ... 0.00 to 10.00 • Deadband ... -50.0 to 50.0% Pulse cycle: 1 second to 180 seconds (cooling side)
Additional event output	Event output point: Relay output 2 points (EV2/EV3) Contact ratings: Resistive load 100VAC 3A, 240VAC 3A 30VDC 3A Inductive load 100VAC 1.5A, 240VAC 1.5A 30VDC 1.5A Minimum load 5VDC or more, 10mADC or more Electrical relay life ... More than 100,000 times Contact protection element ... Not built-in [If required, add a contact protection element (sold separately) externally.]
Heater disconnection detection	Function to detect the heater disconnection by CT input Input signal: 5.0 to 50.0AAC (50/60Hz) Input accuracy: ±5% of full scale ± 1 digit Resolution: Approx. 1/100 CT: Model CTL-6-S-H is required.
Water-proof	For water-proofing of the front panel, a rubber packing is inserted between a controller and a panel board. NEMA250 4X (equivalent to IEC529, IP66) Note) This option cannot be applied for closed-installation.
DC voltage power drive	Power voltage: 24VDC ± 10% [To be supplied from (class 2)] Power consumption: Maximum 8w

ACCESSORIES (Separate purchase is required.)

Accessory	Remarks
Terminal cover	The depth is extended to 132mm by the terminal cover.
Shunt resistor for current input (250Ω)	For measurement by DC current of 4 to 20mA

■ TERMINAL BOARD

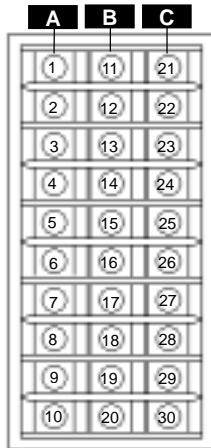

- Note) 1. All terminal screws are M3.5.
 2. For Y-tip or O-tip, use it with the outside dimension of 7mm or less.

Line B Communications/remote contacts input

No.	RS-232C	RS-422A	RS-485
11	SD	SDA	SA
12		SDB	SB
13	RD	RDA	
14		RDB	
15	SG	SG	SG

No.	DI1+	DI2+	DI3+	DI4+	DI-COM
16					
17					
18					
19					
20					

Line A Measuring input/event output 1/control output 1/power supply

Measuring	No.	Voltage (current *)	T/C	RTD
	1			
2		+	+	B
3		-	-	B

* For current input
 Connect a shunt resistor (250Ω, sold separately) to + and - terminals.

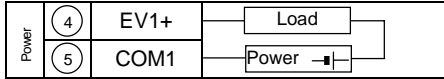

Control output 1 (heating)	No.	On-off pulse output	SSR drive pulse type Current output type Voltage output type
	6	H (NC)	+
7	C (COM)	-	
8	L (NO)		

Power	No.	AC power	DC power (option)
	9	L (live)	+
10	N (Neutral)	-	

Line C Retransmission output/control output 2/CT/additional event output

Retransmission	No.	
	21	+
22	-	

Control output 2 (cooling)	No.	On-off pulse type	SSR drive pulse type
	23	H (NC)	+
24	C (COM)	-	
25	L (NO)		

26	CT
27	CT

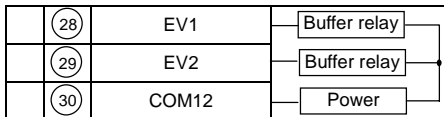

■ DIMENSIONS AND PANEL CUTOUT (Steel plate with thickness of 1 to 10mm is recommended for installation.)

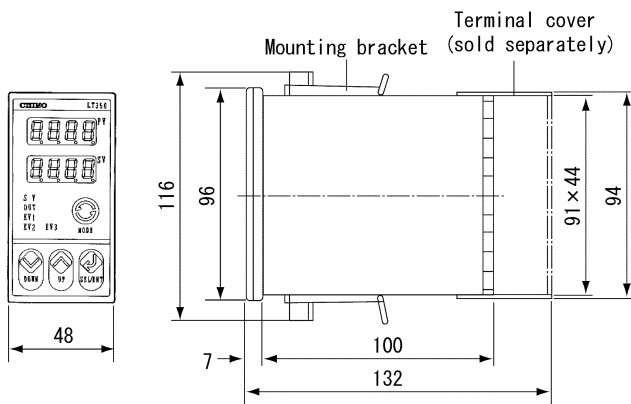

- General installation
- Closed-installation panel dimension (Not applied to optional water-proof)

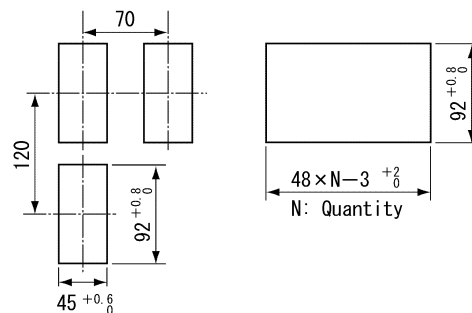

Specifications subject to change without notice. Printed in Japan(I) 2001.9

CHINO CORPORATION

32-8, KUMANO-CHO, ITABASHI-KU, TOKYO 173-8632

PHONE: +81-3-3956-2171

FAX: +81-3-3956-0915

E-mail: inter@chino.co.jp

Website: http://www.chino.co.jp