**User's
Manual**

**Model UP351
Program Controller
User's Manual**



IM 05E01D12-41E

Blank Page

Introduction

Thank you for purchasing the UP351 program controller.

■ How to Use the Manuals

Purpose	Title	Description
Setup	1. Installation	Describes the tasks (installation, wiring, and others) required to make the controller ready for operations.
Basic operation	2. Initial Settings	Describes examples of setting PV input types, and control output types. Making settings described herein and program creation in "3. Programming" allow you to carry out basic control.
Program creation	3. Programming	Describes examples of creating basic programs. See "3.8 Program Pattern Setup Charts," and program functions.
Operating procedures and troubleshooting	4. Operations 5.1 Troubleshooting	Describes key operation sequences. For operation control through external contact inputs, see "1.5 Terminal Wiring Diagrams."
Brief operation and setpoint recording	6. Parameters	Contains the parameter map used as a guideline for setting parameters and lists of parameters for recording User Settings.

■ Regarding This User's Manual

- (1) This manual should be provided to the end user. Keep an extra copy or copies of the manual in a safe place.
- (2) Read this manual carefully to gain a thorough understanding of how to operate this product before starting operation.
- (3) This manual describes the functions of this product. Yokogawa Electric Corporation (hereinafter simply referred to as Yokogawa) does not guarantee the application of these functions for any particular purpose.
- (4) Under absolutely no circumstances may the contents of this manual, in part or in whole, be transcribed or copied without permission.
- (5) The contents of this manual are subject to change without prior notice.
- (6) Every effort has been made to ensure that the details of this manual are accurate. However, should any errors be found or important information be omitted, please contact your nearest Yokogawa representative or our sales office.

■ Safety Precautions

The following symbol is indicated on the controller to ensure safe use.



This symbol on the controller indicates that the operator must refer to an explanation in the user's manual in order to avoid the risk of injury or death of personnel or damage to the instrument. The manual describes how the operator should exercise special care to avoid electric shock or other dangers that may result in injury or loss of life.

The following symbols are used in the hardcopy user's manuals and in the user's manual supplied on the CD-ROM.



Indicates that operating the hardware or software in a particular manner may damage it or result in a system failure.



Draws attention to information that is essential for understanding the operation and/or features of the controller.

■ Force Majeure

- (1) Yokogawa assumes no liability to any party for any loss or damage, direct or indirect, caused by the use or any unpredictable defect of the product.
- (2) No portion of the software supplied by Yokogawa may be transferred, exchanged, leased or sublet for use by any third party without the prior permission of Yokogawa.
- (3) Be sure to use the spare parts approved by Yokogawa when replacing parts or consumables.
- (4) Use this software with one specified computer only. You must purchase another copy of the software for use on each additional computer.
- (5) Copying this software for purposes other than backup is strictly prohibited.
- (6) Store the floppy disk(s) (original medium or media) containing this software in a secure place.

■ Regarding Protection, Safety, and Prohibition Against Unauthorized Modification

- (1) In order to protect the product and the system controlled by it against damage and ensure its safe use, make certain that all of the instructions and precautions relating to safety contained in this document are strictly adhered to. Yokogawa does not guarantee safety if products are not handled according to these instructions.
- (2) Modification of the product is strictly prohibited.
- (3) Reverse engineering such as the disassembly or decompilation of software is strictly prohibited.

Blank Page

Model UP351 Program Controller User's Manual

IM 05E01D12-41E 4th Edition

CONTENTS

- Introduction i
- 1. Installation 1-1
 - 1.1 Model and Suffix Codes..... 1-1
 - 1.2 How to Install..... 1-2
 - 1.3 How to Connect Wires..... 1-5
 - 1.4 Hardware Specifications..... 1-7
 - 1.5 Terminal Wiring Diagrams..... 1-12
- 2. Initial Settings 2-1
 - 2.1 Names and Functions of Front Panel Parts..... 2-2
 - 2.2 Setting PV InputType (Setting First at Power-on)..... 2-3
 - 2.3 Changing PV InputType..... 2-7
 - 2.4 Setting Control OutputType..... 2-9
 - 2.5 Setting the PV display color changing function “Active Color PV Display” ... 2-11
 - 2.6 Setting the High Limit and Low limit for PV Color change..... 2-12
- 3. Programming 3-1
 - 3.1 Overview of Program Patterns..... 3-1
 - 3.2 Example of Program Pattern Setup Charts..... 3-2
 - 3.3 Creating Program Patterns..... 3-3
 - 3.4 Changing Program Patterns..... 3-8
 - 3.5 Program Parameter Map..... 3-10
 - 3.6 Lists of Program Parameters..... 3-11
 - 3.7 Explanation of Program Functions..... 3-16
 - 3.8 Program Pattern Setup Charts..... 3-22
- 4. Operations 4-1
 - 4.1 Monitoring-purpose Operating Displays Available during Operation..... 4-1
 - 4.2 Performing/Canceling Auto-tuning..... 4-2
 - 4.3 Setting PID Manually..... 4-3
 - 4.4 Starting (PRG)/Stopping (RESET) the Controller..... 4-5
 - 4.5 Enabling/Disabling Hold Mode of Program Operation..... 4-7
 - 4.6 Changing Program Setpoints when in Hold Mode..... 4-8
 - 4.7 Executing “Advance” Function..... 4-9

5.	Troubleshooting and Maintenance	5-1
5.1	Troubleshooting.....	5-1
5.2	Maintenance.....	5-4
5.2.1	Cleaning	5-4
5.2.2	Replacing Brackets	5-4
5.2.3	Attaching Terminal Cover	5-4
5.2.4	Replacing Parts with a Limited Service Life	5-6
5.2.5	Replacing Control Output Relays	5-7
6.	Parameters	6-1
6.1	Parameter Map.....	6-1
6.2	Lists of Parameters.....	6-4
7.	Function Block Diagram and Descriptions.....	7-1
	Revision Information	i

1. Installation

This chapter describes installation, wiring, and other tasks required to make the controller ready for operation.

1.1 Model and Suffix Codes

Before using the controller, check that the model and suffix codes match your order.

Model	Suffix Code	Description
UP351		Program controller (provided with retransmission output and 15 V DC loop power supply as standard)
Type	-0	Standard type
Optional functions	0	None
	1	With communication

Check that the following items are provided:

- Program controller (of ordered model) 1
- Brackets (mounting hardware) 1 pair
- Unit label 1
- User’s Manuals 4 (A2 size)
- User’s Manuals
“Setting/Explanation of Active Color PV Display 1 (A3 size)
- User’s Manual (Reference) (CD-ROM version) 1

1.2 How to Install

NOTE

To install the controller, select a location where:

1. no one may accidentally touch the terminals,
2. mechanical vibrations are minimal,
3. corrosive gas is minimal,
4. temperature can be maintained at about 23°C and the fluctuation is minimal,
5. no direct radiant heat is present,
6. no magnetic disturbances are caused,
7. no wind blows against the terminal board (reference junction compensation element),
8. no water is splashed,
9. no flammable materials are around,

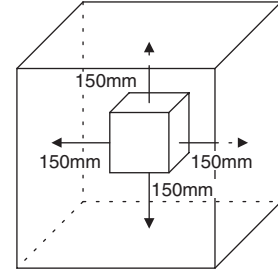

Never place the controller directly on flammable items or equipment.

If the controller has to be installed close to flammable items or equipment, be sure to provide shielding panels all around the controller, at least 150 mm away from every side; the panels should be made of either 1.43 mm-thick metal-plated steel plates or 1.6 mm-thick uncoated steel plates.

NOTE

Never touch the opening at the bottom of the case. It is to be used in the factory at shipping.

● Installation Position

Install the controller at an angle within 30° from horizontal with the front panel facing upward. Do not install it facing downward. The position of right and left sides should be horizontal.

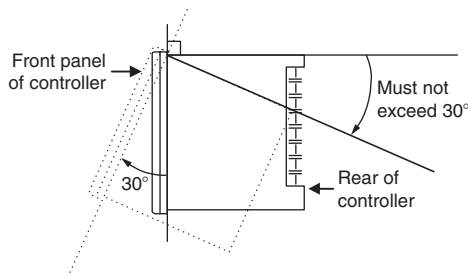

External Dimensions and Panel Cutout Dimensions

UP351

Unit: mm

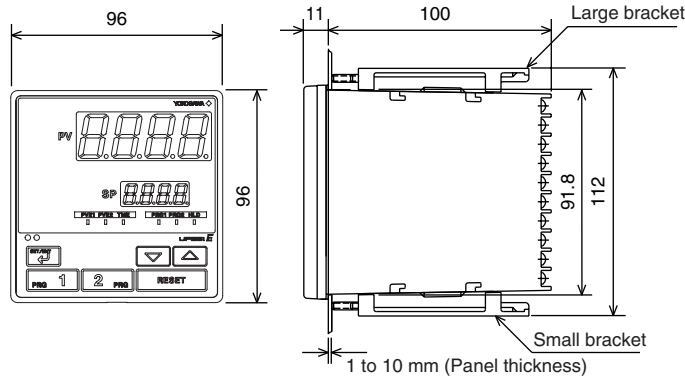

General installation

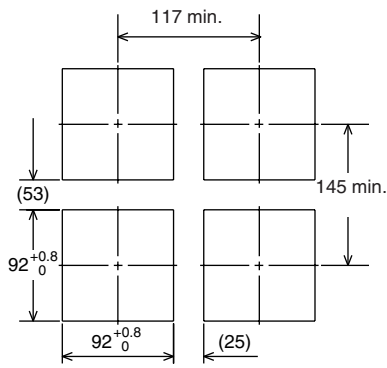

Side-by-side close installation

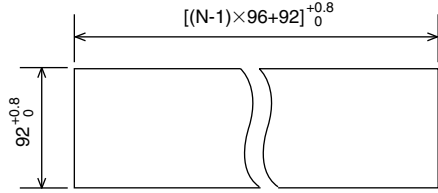

"N" stands for the number of controllers to be installed. However, the measured value applies if $N \geq 5$.

■ How to Install



CAUTION

Turn off the power to the controller before installing it on the panel because there is a possibility of electric shock.

After opening the mounting hole on the panel, follow the procedures below to install the controller:

1. Insert the controller into the opening from the front of the panel so that the terminal board on the rear is at the far side.
2. Set the brackets in place on the top and bottom of the controller as shown in the figure below, then tighten the screws of the brackets. Take care not to overtighten them.

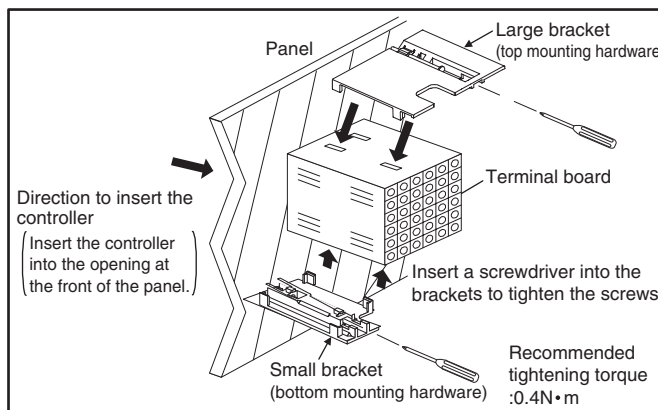

1.3 How to Connect Wires



- 1) Before carrying out wiring, turn off the power to the controller and check that the cables to be connected are not alive with a tester or the like because there is a possibility of electric shock.
- 2) For the protection and safe use of the controller, be sure to place a circuit breaker (conforms with IEC60947, 5A, 100V or 220V AC) near the controller where the breaker can easily be operated. In addition, be sure to indicated that it is the instrument to cut the power supply of the controller.
- 3) Wiring must be carried out by personnel who have basic electrical knowledge and practical experience.



- 1) Provide power from a single-phase instrument power supply. If there is a lot of noise in the power line, insert an insulating transformer into the primary side of the line and use a line filter (recommended part: ZAC2205-00U from TDK) on the secondary side. As a countermeasures against noise, do not place the primary and secondary power cables close to each other.
- 2) For thermocouple input, use shielded compensating lead wires for wiring. For RTD input, use shielded wires that have low conductor resistance and cause no significant differences in resistance between the three wires. The cables to be used for wiring, terminal specifications, and recommended parts are as shown below.
- 3) Control output relays may be replaced. However, because they have a life of 100,000 times that of the resistance load, use auxiliary relays to turn on/off a load.
- 4) The use of inductance (L) loads such as auxiliary relays, motors and solenoid valves causes malfunction or relay failure; always insert a CR filter for use with alternating current or a diode for use with direct current, as a spark-removal surge suppression circuit, into the line in parallel with the load.
- 5) When there is possibility of being struck by external lightening surge, use the arrester to protect the instrument.

■ For DC Relay Wiring

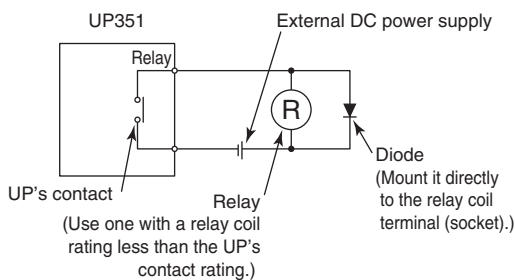

■ For AC Relay Wiring

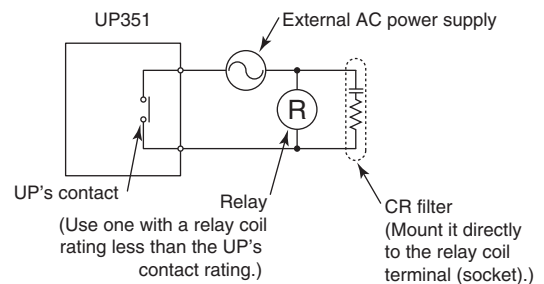

● Cable Specifications and Recommended Cables

Purpose	Name and Manufacturer
Power supply, grounding, relay contact outputs	600 V PVC insulated wires, JIS C 3307, 0.9 to 2.0 mm ²
Thermocouple	Shielded compensating lead wires, JIS C 1610, □X-□-□-□ (See Yokogawa Electric's GS 6B1U1-E.)
RTD	Shielded wires (three conductors), UL2482 (Hitachi Cable)
Other signals	Shielded wires

● Recommended Terminal Lugs

Applicable wire size	Tightening torque
0.3 to 1.65 mm ²	0.8 N·m or less

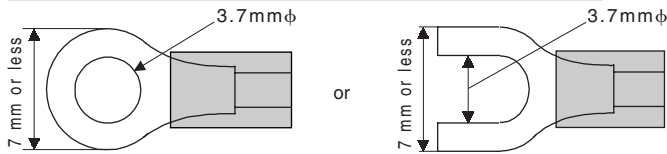

● Terminal Covers

Target Model	Part Number	Sales Unit
UP351	T9115YD	1

1.4 Hardware Specifications

PV Input Signals

- Number of inputs: 1 (terminals ⑪-⑫-⑬)
- Input type: Universal input system. The input type can be selected with the software.
- Sampling period: 250 ms
- Burnout detection: Functions at TC, RTD, standard signal (0.4 to 2 V or 1 to 5 V)
Upscale, downscale, and off can be specified.
For standard signal, burnout is determined to have occurred if it is 0.1 V or less.
- Input bias current: 0.05 μA (for TC or RTD b-terminal)
- Measurement current (RTD): About 0.13 mA
- Input resistance: 1 $\text{M}\Omega$ or more for thermocouple or mV input
About 1 $\text{M}\Omega$ for DC voltage input
- Allowable signal source resistance: 250 Ω or less for thermocouple or mV input
Effects of signal source resistance: 0.1 $\mu\text{V}/\Omega$ or less
2 $\text{k}\Omega$ or less for DC voltage input
Effects of signal source resistance: About 0.01%/100 Ω
- Allowable wiring resistance: for RTD input
Maximum 150 Ω/wire : Conductor resistance between three wires should be equal
However, 10 Ω/wire for a maximum range of -150.0 to 150.0°C .
Wire resistance effect: $\pm 0.1^\circ\text{C}/10 \Omega$
- Allowable input voltage: ± 10 V DC for thermocouple, mV, or RTD input
 ± 20 V DC for DC voltage input
- Noise rejection ratio: 40 dB (50/60 Hz) or more in normal mode
120 dB (50/60 Hz) or more in common mode
- Reference junction compensation error: $\pm 1.0^\circ\text{C}$ (15 to 35°C)
 $\pm 1.5^\circ\text{C}$ (0 to 15°C , 35 to 50°C)
- Applicable standards: JIS, IEC, DIN (ITS-90) for thermocouples and RTD

Loop Power Supply

Power is supplied to a two-wire transmitter.

(15 V DC: terminals ⑭-⑮)

A resistor (10 to 250 Ω) connected between the controller and transmitter converts a current signal into a voltage signal, which is then read via the PV input terminal.

Supply voltage: 14.5 to 18.0 V DC, max. 21 mA (provided with a protection circuit against a field short-circuit)

Retransmission Output

Either PV, program setpoint, or control output is output.

Either the retransmission output or the loop power supply can be used with terminals ⑭-⑮.

- Number of outputs: 1 (terminals ⑭-⑮)
- Output signal: 4-20 mA DC
- Load resistance: 600 Ω or less
- Output accuracy: $\pm 0.3\%$ of span under standard operating conditions ($23 \pm 2^\circ\text{C}$, $55 \pm 10\%$ RH, power frequency of 50/60 Hz)

Control Output

Universal output system, The output type can be selected with the software.

- Current output
(Standard type: terminals ⑩-⑪)

Number of outputs	1 (switched between a voltage pulse output and current output)
Output signal	4-20 mA DC
Load resistance	600 Ω or less
Output accuracy	±0.3% of span under standard operating conditions (23±2°C, 55±10% RH, power frequency of 50/60 Hz)

- Voltage pulse output
(Standard type: terminals ⑩-⑪)

Number of outputs	1 (switched between a voltage pulse output and current output)
Output signal	On-voltage = 12 V or more (load resistance: 600 Ω or more) Off-voltage = 0.1 V DC or less
Resolution	10 ms

- Relay contact output
(Standard type: terminals ①-②-③)

Number of outputs	1
Output signal	Three terminals (NC, NO, and common)
Contact rating	250 V AC or 30 V DC, 3 A (resistance load)
Resolution	10 ms

Contact Inputs

- Purpose: Run/Reset switching
- Number of inputs: 2 points
- Input type: Non-voltage contact or transistor open collector input
- Input contact rating: 12 V DC, 10 mA or more
- On/off determination: For non-voltage contact input, contact resistance of 1 kΩ or less is determined as “on” and contact resistance of 20 kΩ or more as “off.”
For transistor open collector input, input voltage of 2 V or less is determined as “on” and leakage current must not exceed 100 μA when “off.”
- Minimum status detection hold time: About 1 sec.

Contact Outputs

- Purpose: PV event outputs (2) and time event output (1)
- Number of outputs: 3 points
- Relay contact rating: 240 V AC, 1 A, or 30 V DC, 1 A

Display Specifications

- PV display: 4-digit, 7-segment red LED display, character height of 20 mm
- Setpoint display: 4-digit, 7-segment red LED display character height of 9.3 mm
- Status indicating lamps: LEDs

Safety and EMC Standards

- Safety: Complies with IEC/EN61010-1 (CE), approved by C22.2 No.61010-1, approved by UL508.

Installation category : CAT. II Pollution degree : 2 (IEC/EN61010-1, C22.2 No.61010-1)

Measurement category : I (CAT. I : IEC/EN61010-1)

Rated measurement input voltage : 10V DC max.(across terminals), 300V AC max.(across ground)

Rated transient overvoltage : 1500V (Note)

Note : It is a value on the safety standard which is assumed by IEC/EN61010-1 in Measurement category I, and is not the value which guarantees an apparatus performance.



CAUTION

This equipment has Measurement category I, therefore do not use the equipment for measurements within Measurement categories II, III and IV.

Measurement category	Description	Remarks
I	CAT. I	For measurements performed on circuits not directly connected to MAINS.
II	CAT. II	For measurements performed on circuits directly connected to the low voltage installation. Appliances, portable equipments, etc.
III	CAT. III	For measurements performed in the building installation. Distribution board, circuit breaker, etc.
IV	CAT. IV	For measurements performed at the source of the low-voltage installation. Overhead wire, cable systems, etc.

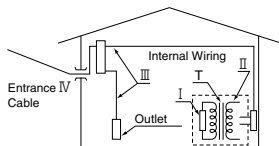

- EMC standards: Complies with EN61326, EN61000-3-2, EN61000-3-3 and EN55011 (CE). AS/NZS 2064 compliant (C-Tick). Class A Group 1.

The instrument continues to operate at a measuring accuracy of within ±20% of the range during tests.

Construction, Installation, and Wiring

- Construction: Dust-proof and drip-proof front panel conforming to IP55. For side-by-side close installation the controller loses its dust-proof and drip-proof protection.
- Material: ABS resin and polycarbonate
- Case color: Black
- Weight: About 1 kg or less
- Dimensions: 96 (W) × 96 (H) × 100 (depth from panel face) mm
- Installation: Panel-mounting type. With top and bottom mounting hardware (1 each)
- Panel cutout dimensions: 92^{+0.8}₀ (W) × 92^{+0.8}₀ (H) mm

- Installation position: Up to 30° upward facing (not designed for facing downward)
- Wiring: M3.5 screw terminals (for signal wiring and power/ground wiring as well)

Power Supply Specifications

- Power supply: Rated voltage of 100 to 240 V AC ($\pm 10\%$), 50/60 Hz
- Power consumption: Max. 20 VA (8.0 W max.)
- Internal fuse rating: 250 V AC, 1.6A time-lag fuse
- Data backup: Non-volatile memory (can be written to up to 100,000 times)
- Withstanding voltage
 - Between primary terminals* and secondary terminals**:
At least 1500 V AC for 1 minute
 - Between primary terminals* and grounding terminal:
At least 1500 V AC for 1 minute
 - Between grounding terminal and secondary terminals**:
At least 1500 V AC for 1 minute
 - Between secondary terminals**:
At least 500 V AC for 1 minute
- * Primary terminals indicate power terminals and relay output terminals
- ** Secondary terminals indicate analog I/O signal, voltage pulse output, and contact input terminals
- Insulation resistance: 20 M Ω or more at 500 V DC between power terminals and grounding terminal
- Grounding: Class D grounding (grounding resistance of 100 Ω or less)

Signal Isolations

- PV input terminals: Isolated from other input/output terminals. Not isolated from the internal circuit.
- 15 V DC loop power supply terminals: Not isolated from 4-20 mA analog output and voltage pulse control output. Isolated from other input/output terminals and internal circuit.
- 4-20 mA analog output terminals (for control output and retransmission): Not isolated between 4-20 mA outputs and from 15 V DC loop power supply and voltage pulse control output. Isolated from other input/output terminals and internal circuit.
- Voltage pulse control output terminals: Not isolated from 4-20 mA outputs and 15 V DC loop power supply. Isolated from other input/output terminals and internal circuit.
- Relay contact control output terminals: Isolated between contact output terminals and from other input/output terminals and internal circuit.
- Contact input terminals: Not isolated between contact input terminals and from communication terminals. Isolated from other input/output terminals and internal circuit.
- Relay contact event output terminal: Not isolated from each other; isolated from other input/output terminals and the internal circuit.
- RS-485 communication terminals: Not isolated from contact input terminals. Isolated from other input/output terminals and internal circuit.
- Power terminals: Isolated from other input/output terminals and internal circuit.
- Grounding terminals: Isolated from other input/output terminals and internal circuit.

Environmental Conditions

- Normal operating conditions:
 - Ambient temperature: 0 to 50°C (40°C or less for side-by-side close installation)
 - Temperature change rate: 10°C/h or less
 - Ambient humidity: 20 to 90% RH (no condensation allowed)
 - Magnetic field: 400 A/m or less
 - Continuous vibration at 5 to 14 Hz: Full amplitude of 1.2 mm or less
 - Continuous vibration at 14 to 150 Hz: 4.9 m/s² or less
 - Short-period vibration: 14.7 m/s², 15 seconds or less
 - Shock: 147 m/s² or less, 11 ms
 - Installation height: Height above sea level of 2000 m or less
 - Warm-up time: 30 minutes or more after power on
- Transportation and storage conditions:
 - Temperature: -25 to 70°C
 - Temperature change rate: 20°C/h or less
 - Humidity: 5 to 95% RH (no condensation allowed)
- Effects of changes in operating conditions
 - Effects from changes in ambient temperature:
 - On voltage or thermocouple input, $\pm 1 \mu\text{V}/^\circ\text{C}$ or $\pm 0.01\%$ of F.S./°C, whichever is larger
 - On RTD input, $\pm 0.05^\circ\text{C}/^\circ\text{C}$ (ambient temperature) or less
 - On analog output, $\pm 0.05\%$ of F.S./°C or less
 - Effects from power supply fluctuation (within rated voltage range)
 - On analog input, $\pm 1 \mu\text{V}/10 \text{ V}$ or $\pm 0.01\%$ of F.S./10 V, whichever is larger
 - On analog output, $\pm 0.05\%$ of F.S./10 V or less

1.5 Terminal Wiring Diagrams



NOTE

Do not use unassigned terminals as relay terminals.

Terminal wiring diagrams are shown on and after the next page.

UP351 Standard Type

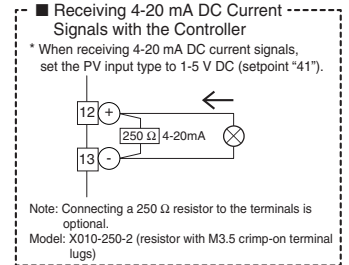
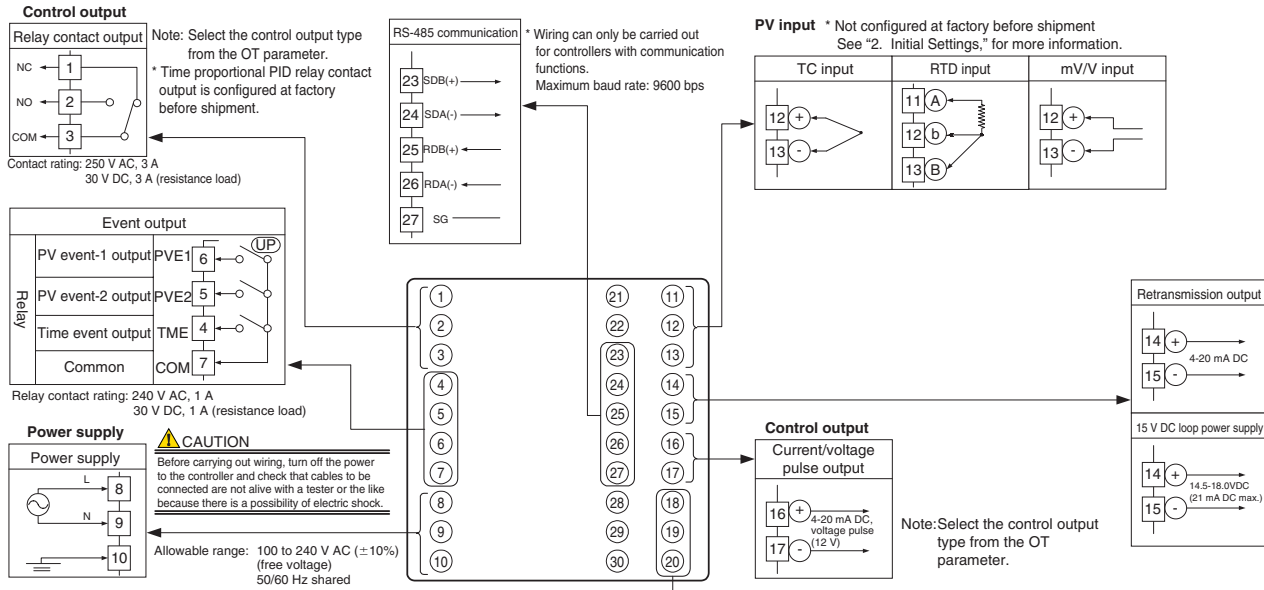

* DIS is a setup parameter.
Changing DIS setpoint allows you to change the function of external contact input.

Correspondence between parameter DIS and external contact input functions

When DIS=OFF (Factory-set default)	When DIS=1	When DIS=2	When DIS=3	(UP) Contact	Transistor contact
No function	Start program 1 when DI1 = ON Reset program 1 when DI1 = OFF	Hide setup parameter lock when DI1 = ON Show setup parameter lock when DI1 = OFF	Start program 1 when DI1 = ON Reset program 1 when DI1 = OFF	DI1 19	
No function	Start program 2 when DI2 = ON Reset program 2 when DI2 = OFF	No function	Hold program when DI2 = ON Cancel hold when DI2 = OFF	DI2 18	
Common	Common	Common	Common	COM 20	

Contact rating: 12 V DC, 10 mA or more

* OT is a setup parameter.
You can change the settings of the parameter OT to change the control output types. See "2. Initial Settings," for more information.

Correspondence between parameter OT and control output types

OT=0 (factory-set default)	OT=1	OT=2	OT=3
Time proportional control Relay output (terminals ①, ② and ③)	Time proportional control Voltage pulse output (terminals ⑫ and ⑬)	Current output (terminals ⑫ and ⑬)	On-off control Relay output (terminals ①, ② and ③)

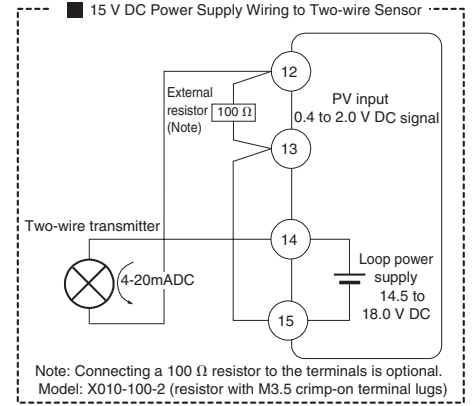

Blank Page



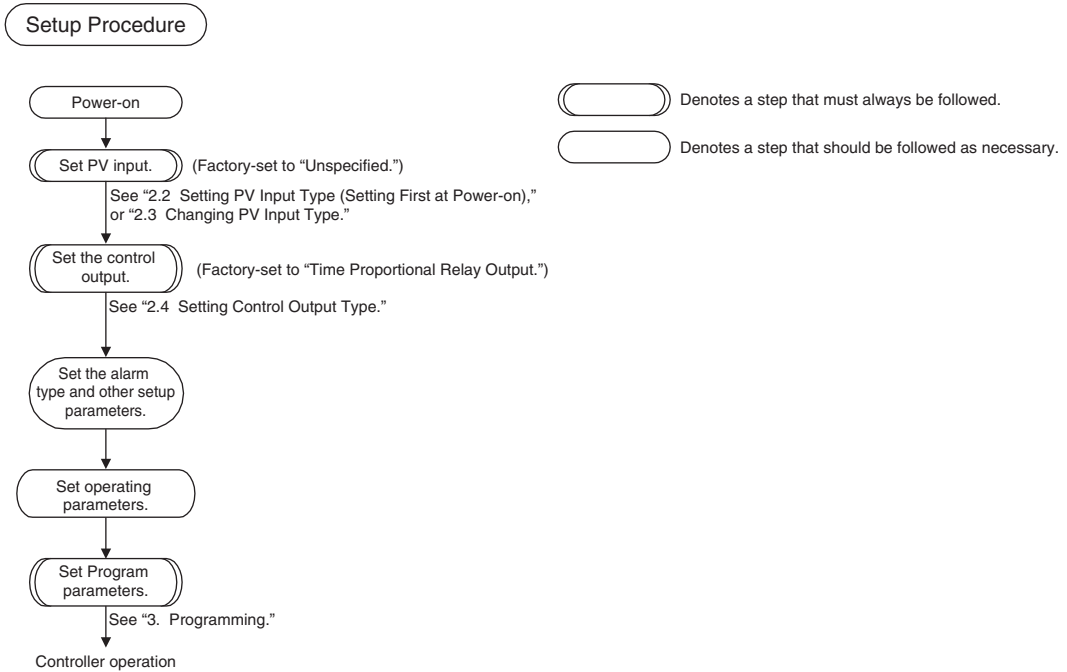

2. Initial Settings

This chapter describes examples of setting PV input types, and control output types. Carrying out settings described herein allows you to perform basic control. Refer to examples of various settings to understand how to set parameters required. Refer to “6.1 Parameter Map” for an easy to understand explanation of setting various parameters. If you cannot remember how to carry out an operation during setting, press the  key for more than 3 seconds. This brings you to the display (operating display) that appears at power-on. When you have finished configuring the initial settings discussed in this manual, create operation programs as explained in “3. Programming.”

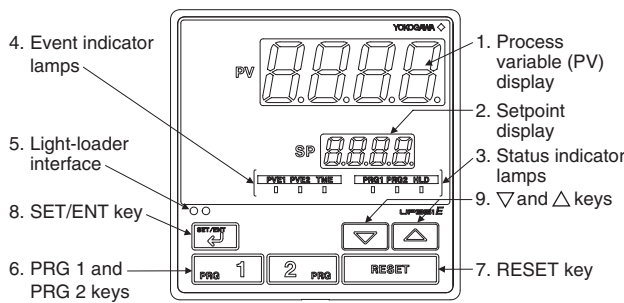

2.1 Names and Functions of Front Panel Parts



Name of Part	Function
1. Process variable (PV) display	<ul style="list-style-type: none"> Displays PV during operation. Displays a parameter symbol when you set a parameter. Displays an error code in red if the controller fails.
2. Setpoint display	<ul style="list-style-type: none"> Displays such data items as the program setpoint and control output value (OUT), as shown below, during operation. <ul style="list-style-type: none"> Program setpoint Segment number for which operation is in progress Remaining segment time Program setpoint at the time of hold (shown when program operation is at a pause) Control output value Displays the setpoint of a parameter when it is configured.
3. Status indicator lamps	Remain lit during operation. <ul style="list-style-type: none"> PRG1: Program-1 operation PRG2: Program-2 operation HLD: Hold operation (lit when program operation is paused)
4. Event indicator lamps	Come on when PV event 1 or 2, or a time event occurs. <ul style="list-style-type: none"> PVE1: PV event 1 PVE2: PV event 2 TME: Time event
5. Light-loader interface	A communication interface for connection with an adapter cable when setting and storing parameters from a PC. Use of this interface requires an optional parameter setting tool.
6. PRG1 and PRG2 keys	Used to start program operation or set a program. <ul style="list-style-type: none"> Operation with program pattern 1: With the operating display shown, hold down the PRG1 key for more than 2 seconds. Operation with program pattern 2: With the operating display shown, hold down the PRG2 key for more than 2 seconds. Setting of program pattern 1: <ul style="list-style-type: none"> With the operating parameter setting display shown, press the PRG1 key to show the relevant program setting parameter. Setting of program pattern 2: <ul style="list-style-type: none"> With the operating parameter setting display shown, press the PRG2 key to show the relevant program setting parameter.
7. RESET key	Press this key for more than 2 seconds during normal operation or hold operation to stop the operation. When stopped, the controller outputs a fixed value (preset output value). The output is factory-set to 0.0% or OFF.
8. SET/ENT key	Used to switch or register parameters. Press this key for more than 3 seconds to alternate between the operating display and the menu for operating parameter setting display.
9.  and  keys	Used to change numerical values. On setting displays for various parameters, you can change the program setpoints, and parameters values. Pressing the  key decreases a numerical value, while pressing the  key causes it to increase. You can hold down either key to gradually increase the speed of change.



IMPORTANT



The controller automatically returns to the display at the time of power-on (i.e., operating display) if no key is operated for at least one minute.

■ Factory-set Values of Main Parameters

Item	Factory-set defaults of standard type controllers
Control output	Time proportional PID relay output (variable)
Control action	Reverse action (variable)
PID parameters	P = 5.0%, I = 240 second, D = 60 second

2.2 Setting PV Input Type (Setting First at Power-on)

NOTE

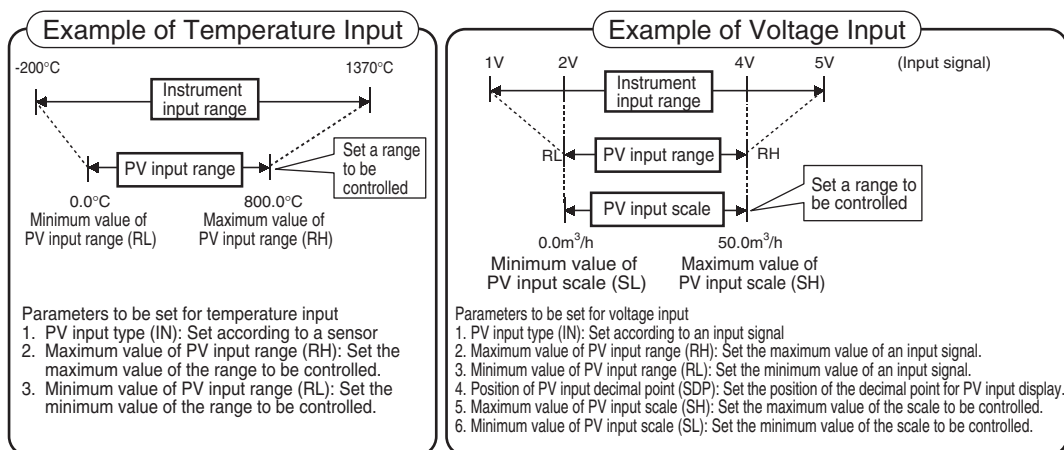

- The controller displays the operating display when the power is turned on. However, if PV input type has not been set, “IN” appears. In this case, first use the  key to display the input range code to use, then press the  key to register it. Then, set the maximum value (RH) and minimum value (RL) of the PV input range (for voltage input, set the maximum value (SH) and minimum value (SL) of the PV input scale).
- The controller is configured to the initial value of each parameter at the factory before shipment.
First check the initial values shown in “6.2 Lists of Parameters,” and change parameter values as necessary.

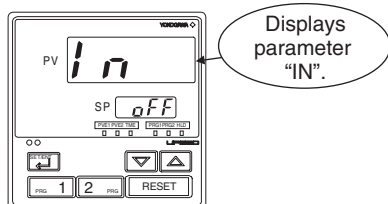

The following operating procedure describes an example of setting a K-type thermocouple (-199.9°C to 500.0°C) and a measurement range of 0.0°C to 200.0°C.

1. **Display screen at power-on**
The parameter “IN” for setting the PV input type appears.



2. **Press the  or  key to display the required setpoint.**
The figure below is an example of the controller setting a K-type thermocouple (-199.9 to 500.0°C). See “Instrument Input Range Codes.”

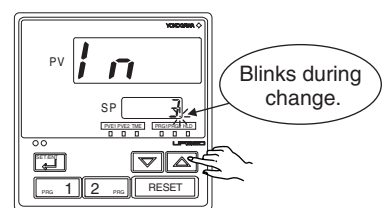

- 3. Press the  key once to register the required setpoint.

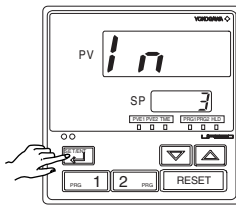

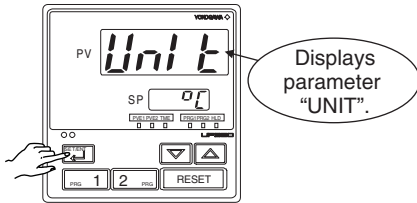

- 4. Press the  key once to display the parameter "UNIT" (PV input unit).

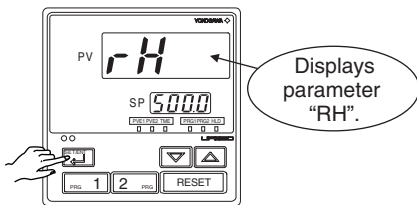

- 5. Press the  key once to display the parameter "RH" (maximum value of PV input range).



- 6. Press the  or  key to display the required setpoint. The figure below shows an example of setting the maximum value of PV input range to 200.0C.

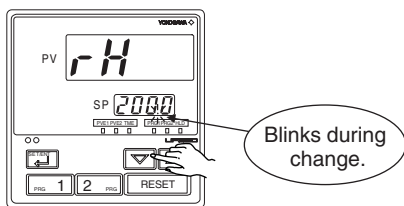

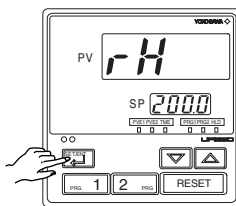

- 7. Press the  key once to register the setpoint.

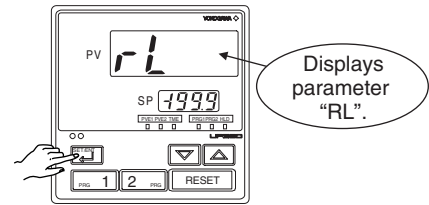

- 8. Press the  key once to display the parameter "RL" (minimum value of PV input range).



- 9. Press the  or  key to display the required setpoint. The figure below shows an example of setting the minimum value of PV input range to 0.0C.

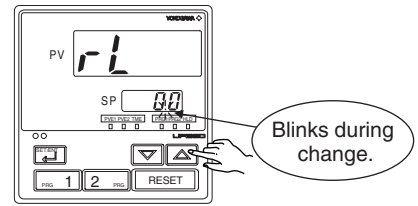

- 10. Press the  key once to register the setpoint.

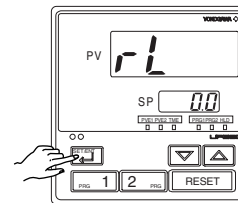

If the type of input is voltage, also configure the PV Input Decimal Point Position(SDP), Maximum Value of PV Input Scale(SH) and Minimum Value of PV Input Scale(SL) parameters that follow this step.

- 11. To set the type of control output, see steps 7 and later in "2.4 Setting Control Output Type." To finish settings, press the  key for more than 3 seconds. This returns you to the display shown at power-on (figure below).

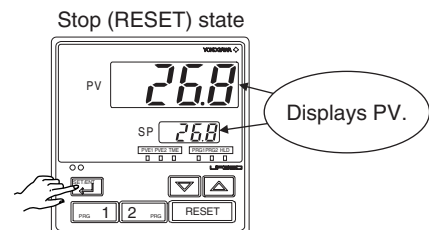

The PV display in the figure above shows the error code for input burnout (b.utt) if PV input wiring is not yet complete. The error code disappears when you wire the PV input terminals correctly

Instrument Input Range Codes

Select the unit from the UNIT parameter.

Input	Type	Instrument Input Range Code	Instrument Input Range	Measurement Accuracy
Unspecified		OFF	Set the data item PV Input Type "IN" to the OFF option to leave the PV input type undefined.	
Thermocouple	K	1	-200 to 1370°C -300 to 2500°F	±0.1% of instrument range ±1 digit for temperatures equal to or higher than 0°C ±0.2% of instrument range ±1 digit for temperatures below 0°C
		2	-199.9 to 999.9°C 0 to 2300°F	
		3	-199.9 to 500.0°C -199.9 to 999.9°F	
	J	4	-199.9 to 999.9°C -300 to 2300°F	
		T	5	
	6		0.0 to 400.0°C -199.9 to 750.0°F	
	B	7	0 to 1800°C 32 to 3300°F	±0.15% of instrument range ±1 digit for temperatures equal to or higher than 400°C ±5% of instrument range ±1 digit for temperatures below 400°C
	S	8	0 to 1700°C 32 to 3100°F	±0.15% of instrument range ±1 digit
	R	9	0 to 1700°C 32 to 3100°F	
	N	10	-200 to 1300°C -300 to 2400°F	±0.1% of instrument range ±1 digit ±0.25% of instrument range ±1 digit for temperatures below 0°C
	E	11	-199.9 to 999.9°C -300 to 1800°F	±0.1% of instrument range ±1 digit for temperatures equal to or higher than 0°C ±0.2% of instrument range ±1 digit for temperatures below 0°C
	L(DIN)	12	-199.9 to 900.0°C -300 to 1300°F	
	U(DIN)	13	-199.9 to 400.0°C -300 to 750°F	±0.2% of instrument range ±1 digit for temperatures below 0°C
			0.0 to 400.0°C -199.9 to 750.0°F	
	W	15	0 to 2300°C 32 to 4200°F	±0.2% of instrument range ±1 digit
	Platinel 2	16	0 to 1390°C 32 to 2500°F	±0.1% of instrument range ±1 digit
	PR20-40	17	0 to 1900°C 32 to 3400°F	±0.5% of instrument range ±1 digit for temperatures equal to or higher than 800°C No guarantee of accuracy for temperatures below 800°C
	W97Re3- W75Re25	18	0 to 2000°C 32 to 3600°F	±0.2% of instrument range ±1 digit
RTD	JPt100	30	-199.9 to 500.0°C -199.9 to 999.9°F	±0.1% of instrument range ±1 digit (Note 1) (Note 2)
		31	-150.0 to 150.0°C -199.9 to 300.0°F	±0.2% of instrument range ±1 digit (Note 1)
	Pt100	35	-199.9 to 850.0°C -300 to 1560°F	±0.1% of instrument range ±1 digit (Note 1) (Note 2)
		36	-199.9 to 500.0°C -199.9 to 999.9°F	
		37	-150.0 to 150.0°C -199.9 to 300.0°F	±0.2% of instrument range ±1 digit (Note 1)
Standard signal	0.4 to 2 V	40	0.400 to 2.000 V	±0.1% of instrument range ±1 digit The read-out range can be scaled between -1999 and 9999.
	1 to 5 V	41	1.000 to 5.000 V	
DC voltage	0 to 2 V	50	0.000 to 2.000 V	
	0 to 10 V	51	0.00 to 10.00 V	
	-10 to 20 mV	55	-10.00 to 20.00 mV	
	0 to 100 mV	56	0.0 to 100.0 mV	

* Performance in the standard operating condition (at 23±2°C, 55±10%RH, and 50/60 Hz/ power frequency)

Note 1: The accuracy is ±0.3°C of instrument range ±1 digit for a temperature range from 0°C to 100°C.

Note 2: The accuracy is ±0.5°C of instrument range ±1 digit for a temperature ranges from -100°C to 0°C and 100°C to 200°C.

* To receive a 4-20 mA DC signal, select a standard signal of 1 to 5 V DC and connect it to a 250 Ω resistor. This resistor is optional.
Model: X010-250-2 (resistor with M3.5 crimp-on terminal lugs)

**NOTE**

The controller may automatically initialize the registered operating parameter setpoints if any change is made to the data item PV Input Type (IN), Maximum Value of PV Input Range (RH), Minimum Value of PV Input Range (RL), PV Input Decimal Point Position (SDP), Maximum Value of PV Input Scale (SH) or Minimum Value of PV Input Scale (SL). After a change has been made to any of these data items, be sure to verify the registered operating parameter setpoints to ensure that they are correct. If any data item has been changed to its default, set it to a required value.

2.3 Changing PV Input Type

The following operating procedure describes an example of changing the setting of K-type thermocouple (-199.9 to 500.0°C) to RTD Pt100 (-199.9 to 500.0°C) and a measurement range of 0.0 to 200.0°C.

PV input terminal	
Thermocouple/mV/V input.....	⑫-⑬
RTD input	⑪-⑫-⑬

1. Bring the operating display into view (display appears at power on).

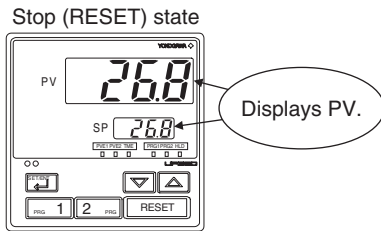

2. Press the key for more than 3 seconds to call up the menu "QPA".

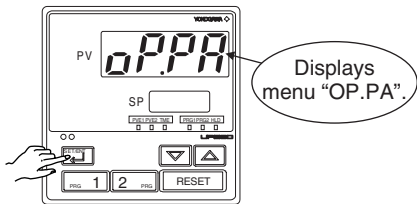

3. Press the key once to display the menu "STUP".

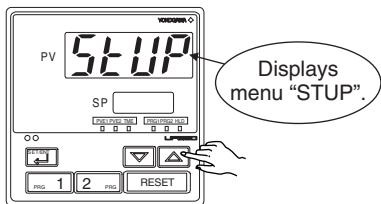

4. Press the key once to display the parameter "PWD".

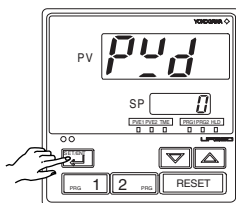

5. Press the key once to display the menu "FUNC".

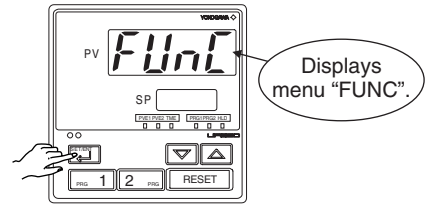

6. Press the key once to display the menu "I/O".

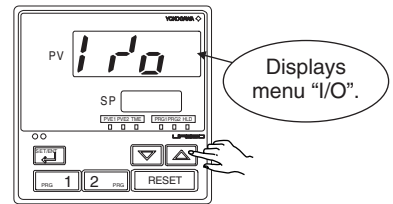

7. Press the key once to display the parameter "IN" (PV input type).

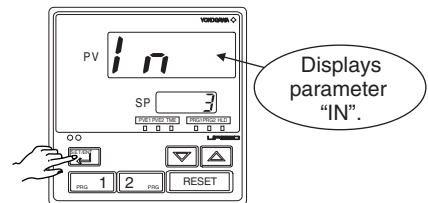

8. Press the or key to display the required setpoint. The figure below shows an example of changing to RTD Pt100 (-199.9 to 500.0°C).

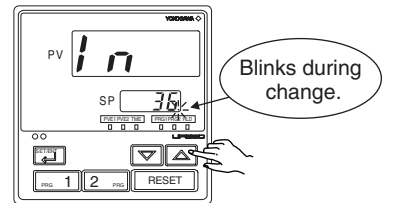

- 9. Press the  key once to register the setpoint.

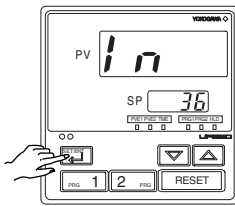

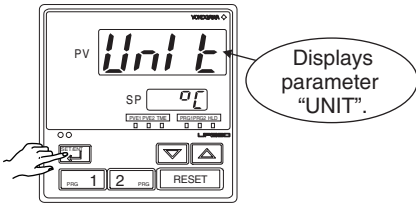

- 10. Press the  key once to display the parameter "UNIT" (PV input unit).

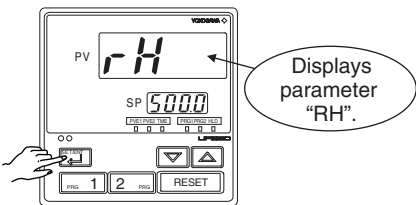

- 11. Press the  key once to display the parameter "RH" (maximum value of PV input range).



- 12. Press the  or  key to display the required setpoint. The figure below shows an example of setting the maximum value of PV input range to 200.0.

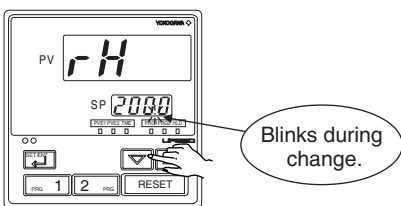

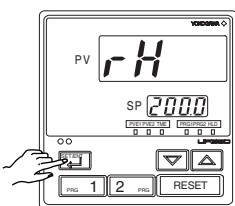

- 13. Press the  key once to register the setpoint.

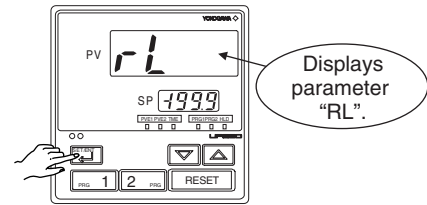

- 14. Press the  key once to display the parameter "RL" (minimum value of PV input range).



- 15. Press the  or  key to display the required setpoint. The figure below shows an example of setting the minimum value of PV input range to 0.0.

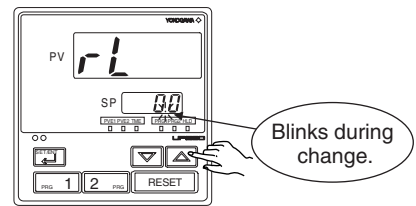

- 16. Press the  key once to register the setpoint.

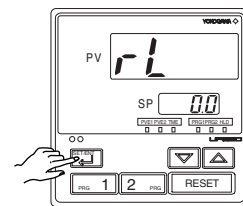

- 17. Press the  key for more than 3 seconds. This returns you to the display shown at power-on (figure below).

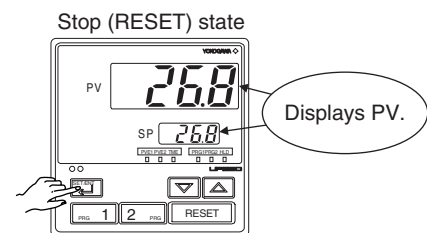

* If the type of input is voltage, also configure the PV Input Decimal Point Position (SDP), Maximum Value of PV Input Scale (SH) and Minimum Value of PV Input Scale (SL) parameters that are displayed after parameter RL.

2.4 Setting Control Output Type

The following operating procedure describes an example of changing time proportional PID relay output (0: factory-set default) to current output (2).

Control output terminal	Values in parentheses are setpoints
Time proportional PID relay (0)/on-off(3) output.....	①-②-③
Current (2)/time proportional PID voltage pulse (1) output.....	⑩-⑰

1. Bring the operating display into view (appears at power-on).

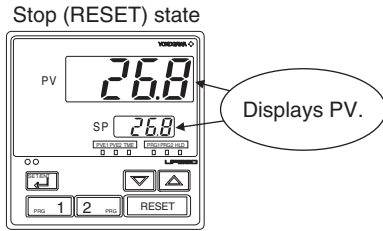

2. Press the key for more than 3 seconds to call up the menu "QPA".

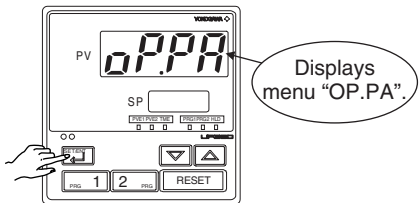

3. Press the key once to display the menu "STUP".

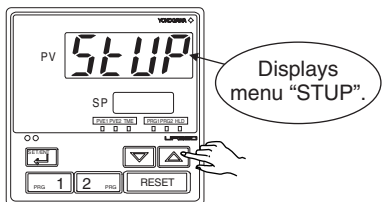

4. Press the key once to display the parameter "PWD".

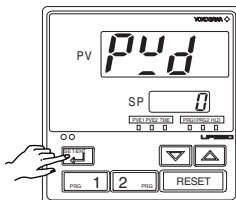

5. Press the key once to display the menu "FUNC".

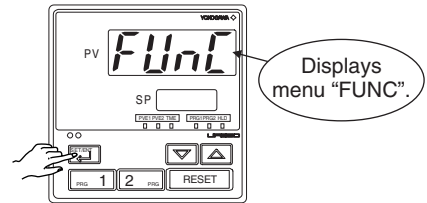

6. Press the key once to display the menu "I/O".

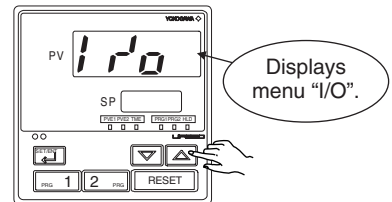

7. Press the key several times to display the parameter "OT" (control output type).

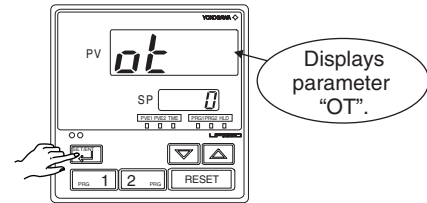

8. Press the or key to display the required setpoint. The figure below shows an example of setting to current output (4 to 20 mA DC).

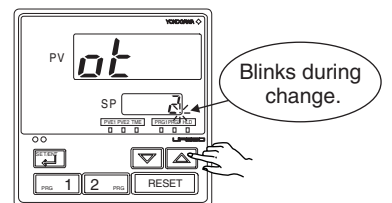

- 9. Press the  key once to register the setpoint.

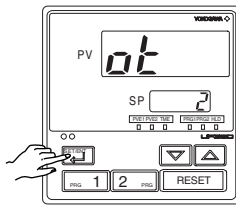

- 10. Press the  key for more than 3 seconds. This returns you to the display shown at power-on (figure below).

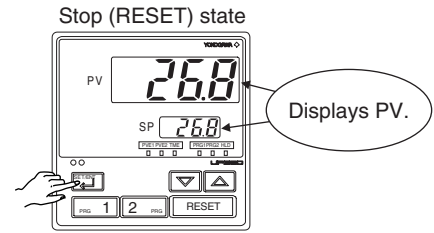









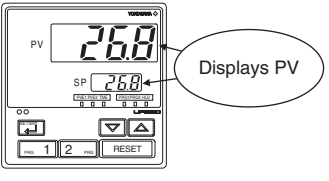

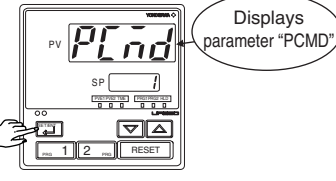

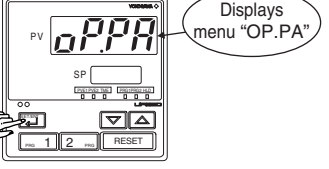

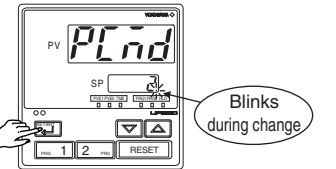

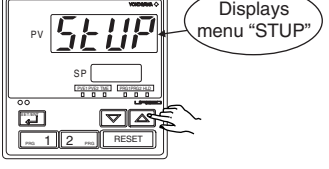
● List of Control Output Types

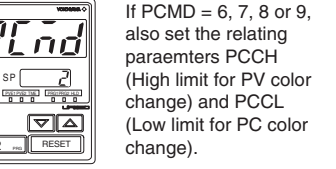
Parameter Symbol	Parameter Name	Setpoint	Control Output Type
 (OT)	Control output type	0	Time proportional PID relay contact output (terminals ①-②-③)
		1	Time proportional PID voltage pulse output (terminals ⑩-⑪)
		2	Current output (terminals ⑩-⑪)
		3	On-off control relay contact output (terminals ①-②-③)

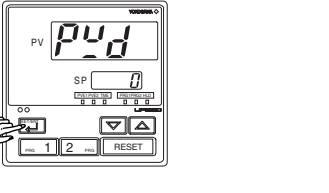

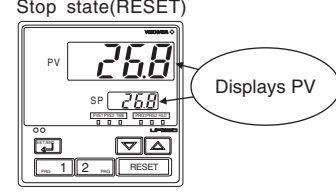

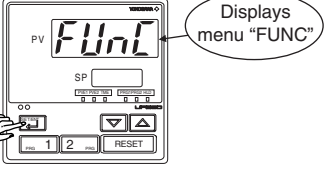



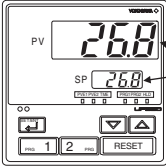

2.5 Setting the PV display color changing function “Active Color PV Display”

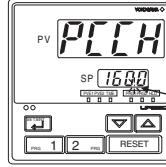
The following operating procedure describes an example of changing PV color mode (factory-set default: Fixed in red mode) to Link to PV event 1 mode.

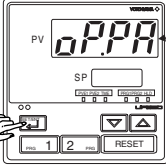
<p>(1) Bring the operating display into view (appears at power on).</p> <p>Stop state(RESET)</p> 	<p>(6) Press the  key several times to display the menu “PCMD” (PV color mode).</p> 
<p>(2) Press the  key for more than 3 seconds to call up the menu “OP.PA.”</p> 	<p>(7) Press the  key or  key to display the required setpoint. The figure below shows an example of setting Link to alarm 1 mode.</p> 
<p>(3) Press the  key once to display the menu “STUP.”</p> 	<p>(8) Press the  key once to register the setpoint.</p>  <p>If PCMD = 6, 7, 8 or 9, also set the relating parameters PCCH (High limit for PV color change) and PCCL (Low limit for PC color change).</p>
<p>(4) Press the  key once to display the parameter “PWD.”</p> 	<p>(9) Press the  key for more than 3 seconds. This returns you to the display shown at power-on (figure blow).</p> <p>Stop state(RESET)</p> 
<p>(5) Press the  key once to display the menu “FUNC.”</p> 	

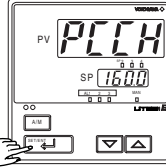
2.6 Setting the High Limit and Low limit for PV Color change

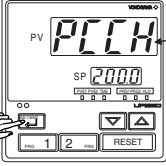
The following operating procedure describes an example of changing PV display color by linking to PV. Set High limit and Low limit for PV color change. Setting for both of High limit and Low limit is required.

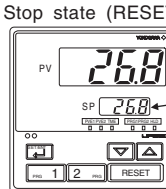
<p>(1) Bring the operating display into view (appears at power-on). Stop state (RESET)</p>  <p>Displays PV.</p>	<p>(4) Press the  key or  key to display the required setpoint.</p>  <p>Blinks during change.</p>
<p>(2) Press the  key for more than 3 seconds to call up the menu "OP.PA."</p>  <p>Displays menu "OP.PA."</p>	<p>(5) Press the  key once to register the setpoint.</p>  <p>PCCL (Low limit for PV color change parameter) that is displayed after this can be</p>
<p>(3) Press the  key several times to display the parameter "PCCH."</p>  <p>Displays parameter "PCCH."</p>	<p>(6) Press the  key for more than 3 seconds. This returns you to the display shown at power-on (figure below).</p> <p>Stop state (RESET)</p>  <p>Displays PV.</p>

3. Programming

This chapter explains how to create programs by citing specific examples. Create user programs by referring to the given programming examples. Programming is not possible when the controller is set in Run mode (PRG). Place the controller in Stop (RESET) mode before you start programming.

Be sure to carry out the settings instructed in “2. Initial Settings” before beginning any of the tasks discussed in this chapter.

3.1 Overview of Program Patterns

■ Programming Overview

The programming example given here demonstrates how to do the tasks outlined below.

1. Program the controller to start program operation at 25°C and raise the temperature up to 80°C in 20 minutes.
2. When the temperature reaches 80°C, keep it at this level for 80 minutes.
3. Finally, lower the temperature to 0°C in 10 minutes.

Event output

- Set a deviation of 5°C on both the positive and negative sides of a program setpoint to let the controller output an event signal if the temperature goes beyond the deviation range.
- Let the controller output an event signal when the temperature stabilizes to 80°C.

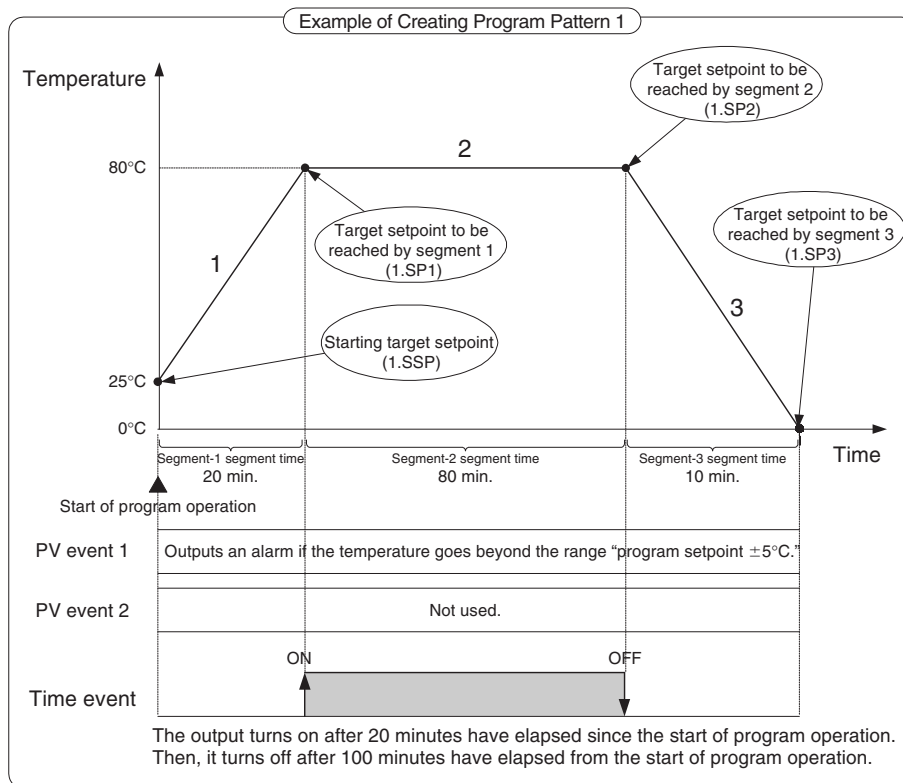

3.2 Example of Program Pattern Setup Charts

Complete the following setup chart before setting programs in the controller. Filling in the chart makes it easier for you to input program data into the controller. See “3.8 Program Pattern Setup Charts” for more details.

In the following chart, fill in the fields with bold-face borders.

1. Maximum value of PV input range: Setpoint of the “Maximum Value of PV Input Range (RH)” setup parameter
2. Minimum value of PV input range: Setpoint of the “Minimum Value of PV Input Range (RL)” setup parameter
3. PV input unit: Setpoint of the “PV Input Unit (UNIT)” setup parameter
4. Program time unit: Setpoint of the “Program Time Unit (TMU)” setup parameter
5. Segment setting method: Setpoint of the “Segment Setting Method (SEG.T)” setup parameter
6. Starting target setpoint: Setpoint of the “Starting Target Setpoint (SSP)” program parameter
7. Start code: Setpoint of the “Start Code (STC)” program parameter
8. Junction code: Setpoint of the “Junction Code (JC)” program parameter
9. Target setpoint, Segment time, PV events 1 and 2, and Time event: Setpoint of each program parameter
10. Draw the program pattern.

Example of Chart Entries

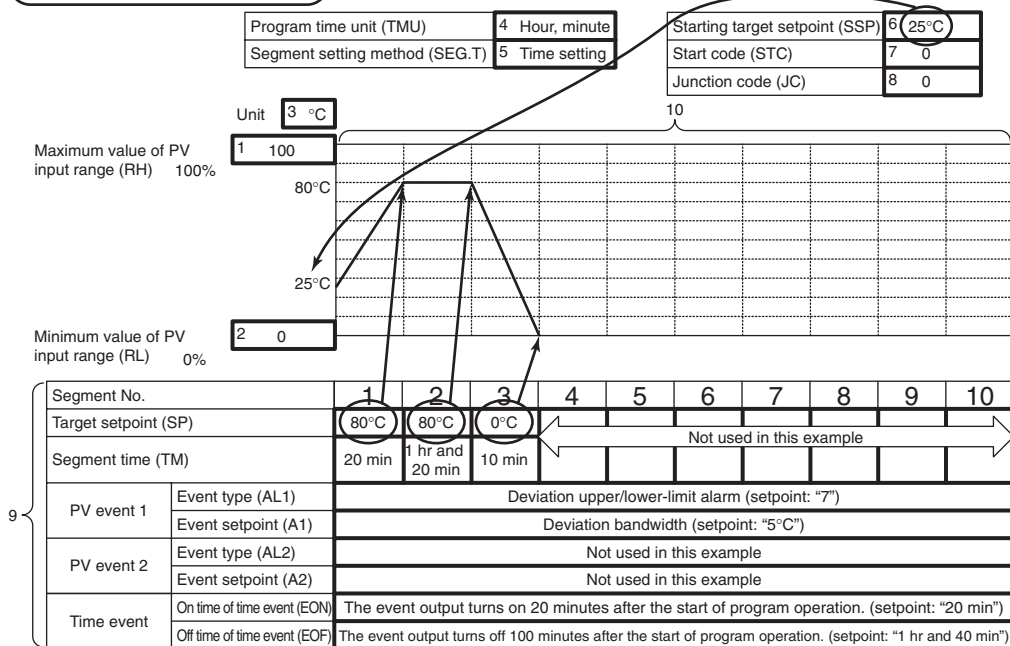

3.3 Creating Program Patterns

The following operating procedure describes an example of creating the program discussed in “3.1 Overview of Program Patterns.”



NOTE

Before creating the program, reverify the Maximum Value of PV Input Range (RH), Minimum Value of PV Input Range (RL), Program Time Unit (TMU), and Segment Setting Method (SEG.T) parameters.

If the setting of the setup parameter “SEG.T” is changed, the program patterns created and stored so far will be all cleared (initialized) !! Be careful.

The programming example given in this section includes the following steps.

- Steps 4 to 9 configure the PV Event 1 parameter (i.e., a procedure for outputting an alarm if the temperature goes beyond the range “program setpoint $\pm 5^{\circ}\text{C}$.”)
- Step 10 configures the PV Event 2 parameter (not configured here).
- Steps 11 to 13 configure the On time of Time Event (1.EON) parameter.
- Steps 14 to 16 configure the Off Time of Time Event (1.EOF) parameter .
- Steps 17 to 19 configure the Starting Target Setpoint (1.SSP) parameter.
- Step 20 configures the Start Code (1.STC) parameter (not configured here).
- Steps 21 to 23 configure the Segment-1 Target Setpoint (1.SP1) parameter.
- Steps 24 to 26 configure the Segment-1 Segment Time (1.TM1) parameter.
- Step 27 configures the Segment-2 Target Setpoint (1.SP2) parameter.
- Steps 28 to 30 configure the Segment-2 Segment Time (1.TM2) parameter.
- Steps 31 to 33 configure the Segment-3 Target Setpoint (1.SP3) parameter.
- Steps 34 to 36 configure the Segment-3 Segment Time (1.TM3) parameter.

1. Bring the operating display into view (appears at power-on).

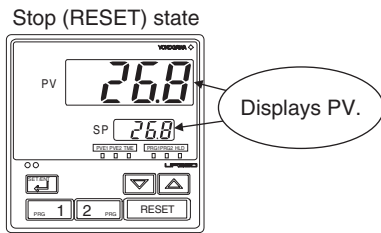

2. Press the key for more than 3 seconds to call up the menu "QPA".

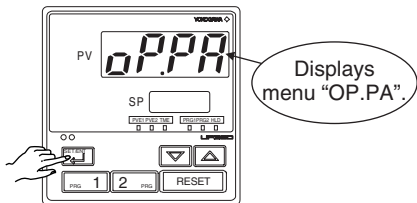

3. Press the key once to display the parameter "LL".

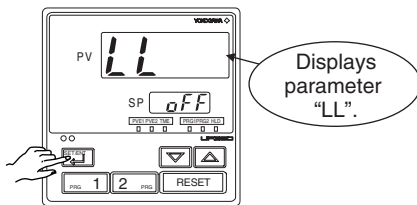

4. Press the key once to display the parameter "1.AL1".

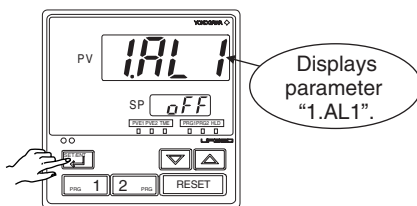

5. Press the or key to display the required setpoint. The figure below shows an example of the parameter set to "Deviation High and Low limit Alarm". (setpoint 7)

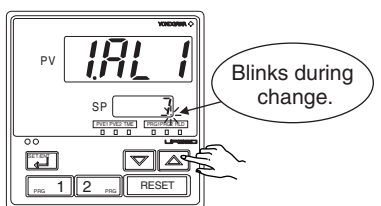

6. Press the key once to register the setpoint.

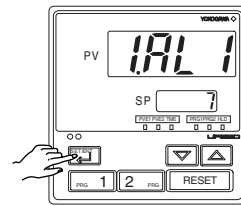

7. Press the key once to display the parameter "1.A1".

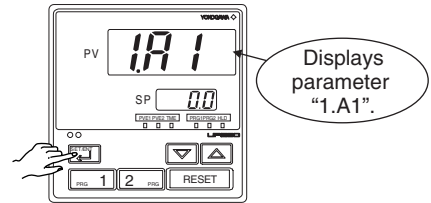

8. Press the or key to display the required setpoint. The figure below shows an example of the parameter set to "5.0".

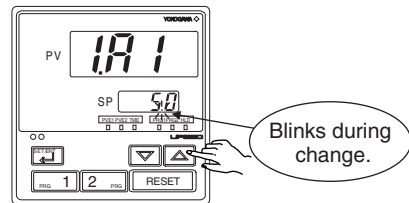

9. Press the key once to register the setpoint.

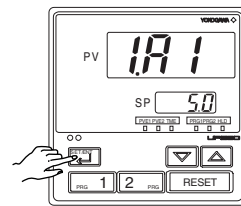

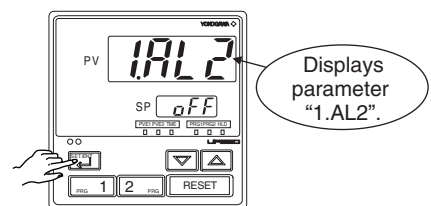

10. Press the key once to display the parameter "1.AL2". The setpoint of this parameter is not changed in this example.

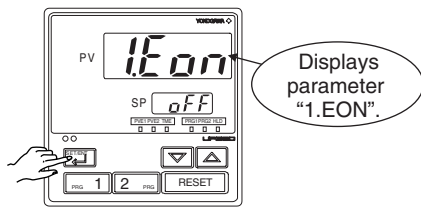

- 11. Press the  key once to display the parameter "1.EON".



- 12. Press the  or  key to display the required setpoint. The figure below shows an example of the parameter set to "20 min".

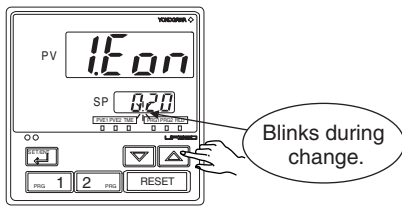

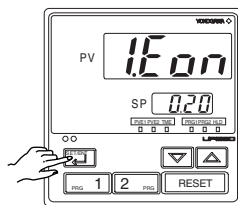

- 13. Press the  key once to register the setpoint.

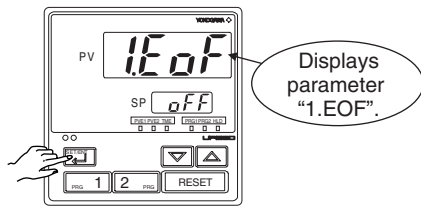

- 14. Press the  key once to display the parameter "1.EOF".



- 15. Press the  or  key to display the required setpoint. The figure below shows an example of the parameter set to "1 hr and 40 min".

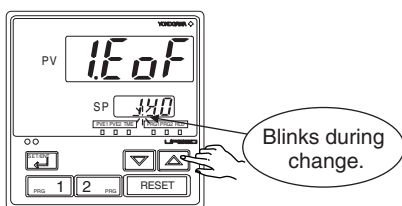

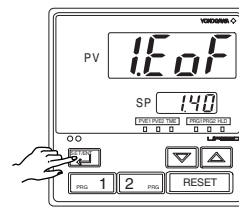

- 16. Press the  key once to register the setpoint.

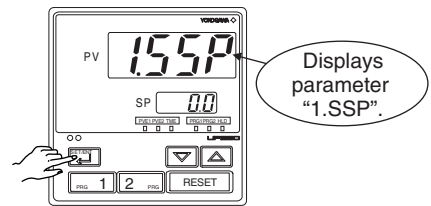

- 17. Press the  key once to display the parameter "1.SSP".



- 18. Press the  or  key to display the required setpoint. The figure below shows an example of the parameter set to "25.0C".

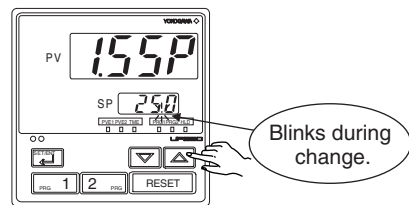

- 19. Press the  key once to register the setpoint.

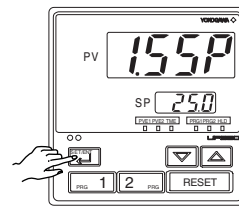

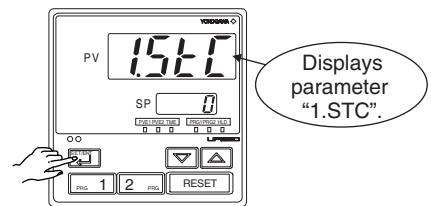

- 20. Press the  key once to display the parameter "1.STC".

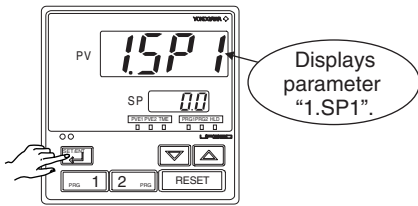

- 21. Press the  key once to display the parameter "1.SP1".



- 22. Press the  or  key to display the required setpoint. The figure below shows an example of the parameter set to "80.0".

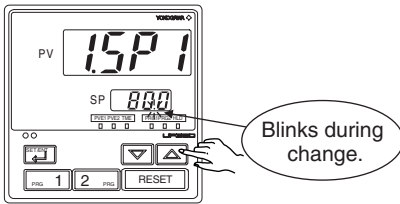

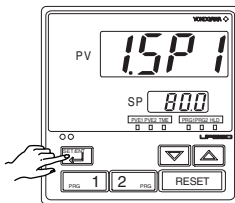

- 23. Press the  key once to register the setpoint.

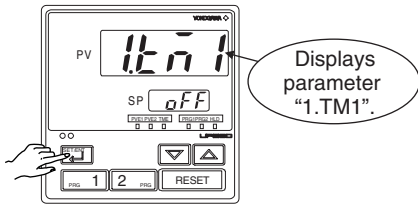

- 24. Press the  key once to display the parameter "1.TM1".



- 25. Press the  or  key to display the required setpoint. The figure below shows an example of the parameter set to "20 min".

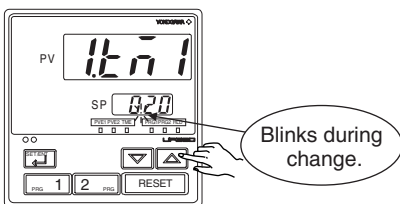

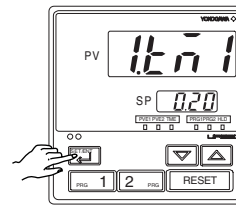

- 26. Press the  key once to register the setpoint.

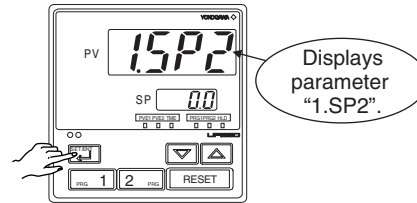

- 27. Press the  key once to display the parameter "1.SP2".



- 28. Press the  or  key to display the required setpoint. The figure below shows an example of the parameter set to "80.0".

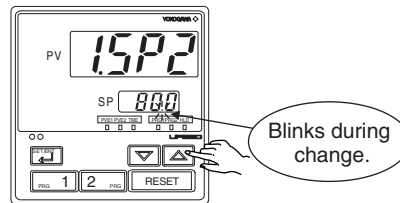

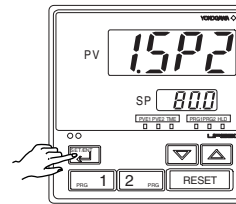

- 29. Press the  key once to register the setpoint.

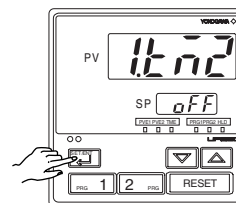

- 30. Press the  key once to display the parameter "1.TM2".



31. Press the  or  key to display the required setpoint.
The figure below shows an example of the parameter set to "1 hr and 20 min".

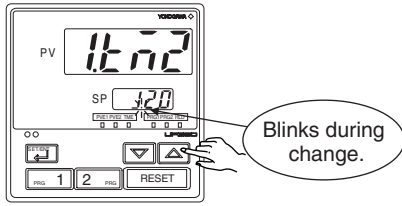

32. Press the  key once to register the setpoint.

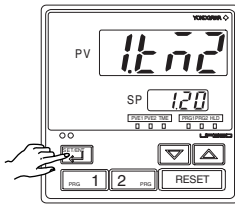

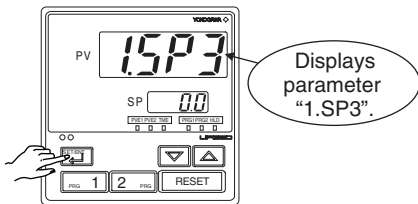

33. Press the  key once to display the parameter "1.SP3".
The setpoint of this parameter is not changed in this example.

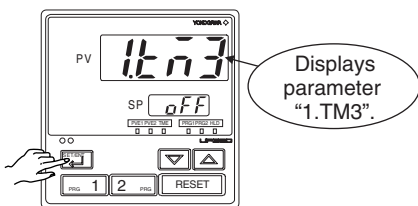

34. Press the  key once to display the parameter "1.TM3".



35. Press the  or  key to display the required setpoint.
The figure below shows an example of the parameter set to "10 min".

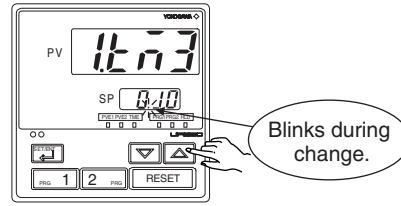

36. Press the  key once to register the setpoint.

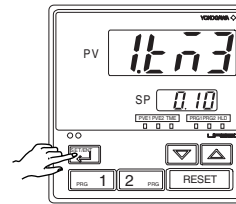

With the steps discussed above, up to three segments of the controller are programmed.
To program the controller for a 4th segment or more, repeat steps 21 to 36.

[TIP]

The parameter "1.JC" (Junction Code) that follows the "1.TMA(Segment-10 Time Event) parameter is used to determine how the controller should behave at the end of program operation.
If the behavior need not be defined, leave the parameter set as "1.JC 0".

37. Now programming is complete. Press the  key for more than 3 seconds.
This returns you to the display shown at power-on (figure below).

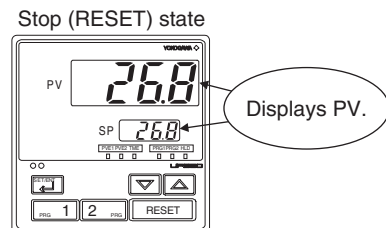

3.4 Changing Program Patterns

The following operating procedure describes an example of changing the program pattern created in “3.3 Creating Program Patterns,” as shown in the figure below.

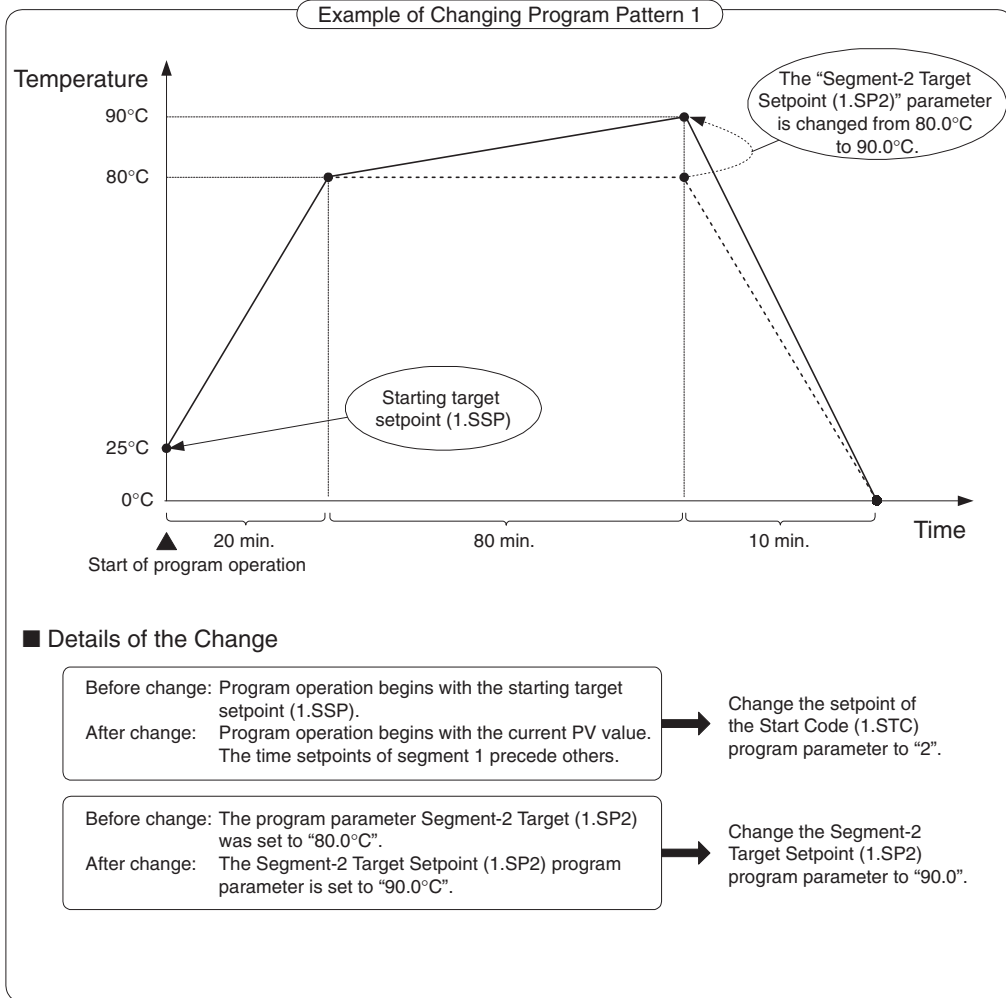

1. Bring the operating display into view (appears at power-on).

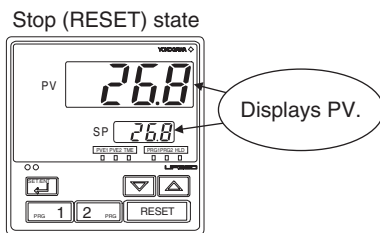

2. Press the  key for more than 3 seconds to call up the menu "QPA".

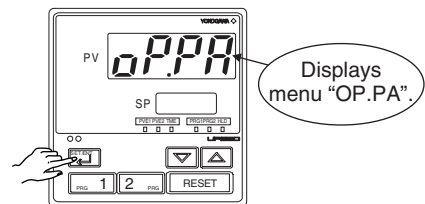

- 3. Press the  key once to display the parameter "LL".

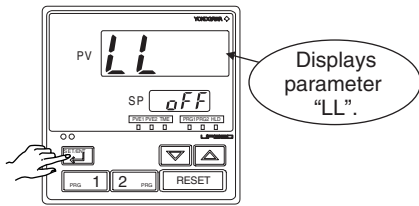

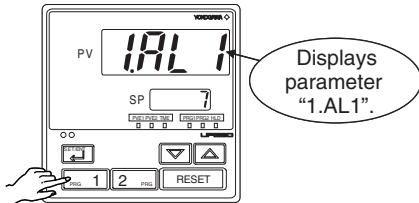

- 4. Press the  key once to display the parameter "1.AL1".

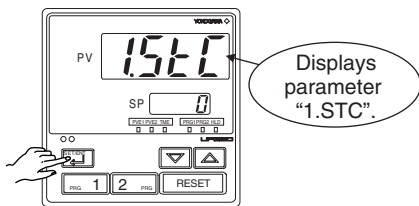

- 5. Press the  key several times to display the parameter "1.STC".



- 6. Press the  or  key to display the required setpoint. The figure below shows an example of the parameter set to "2" (time-prioritized PV start).

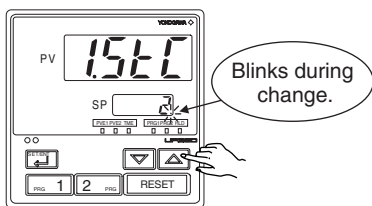

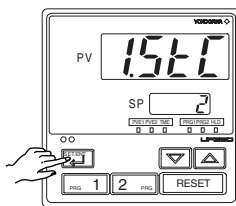

- 7. Press the  key once to register the setpoint.

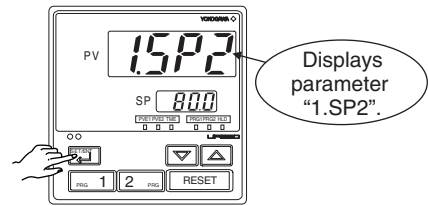

- 8. Press the  key several times to display the parameter "1.SP2".



- 9. Press the  or  key to display the required setpoint. The figure below shows an example of the parameter set to "90.0".

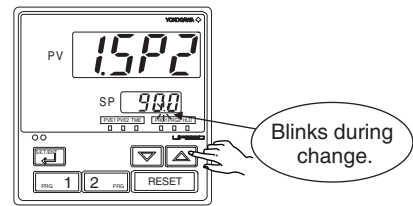

- 10. Press the  key once to register the setpoint.

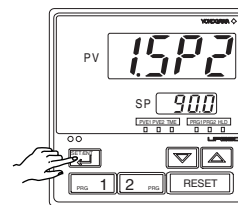

- 11. Changing the program is now complete. Press the  key for more than 3 seconds. This returns you to the display shown at power-on (figure below).

Stop (RESET) state

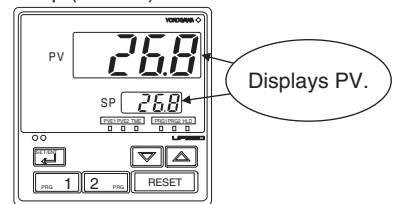

3.5 Program Parameter Map

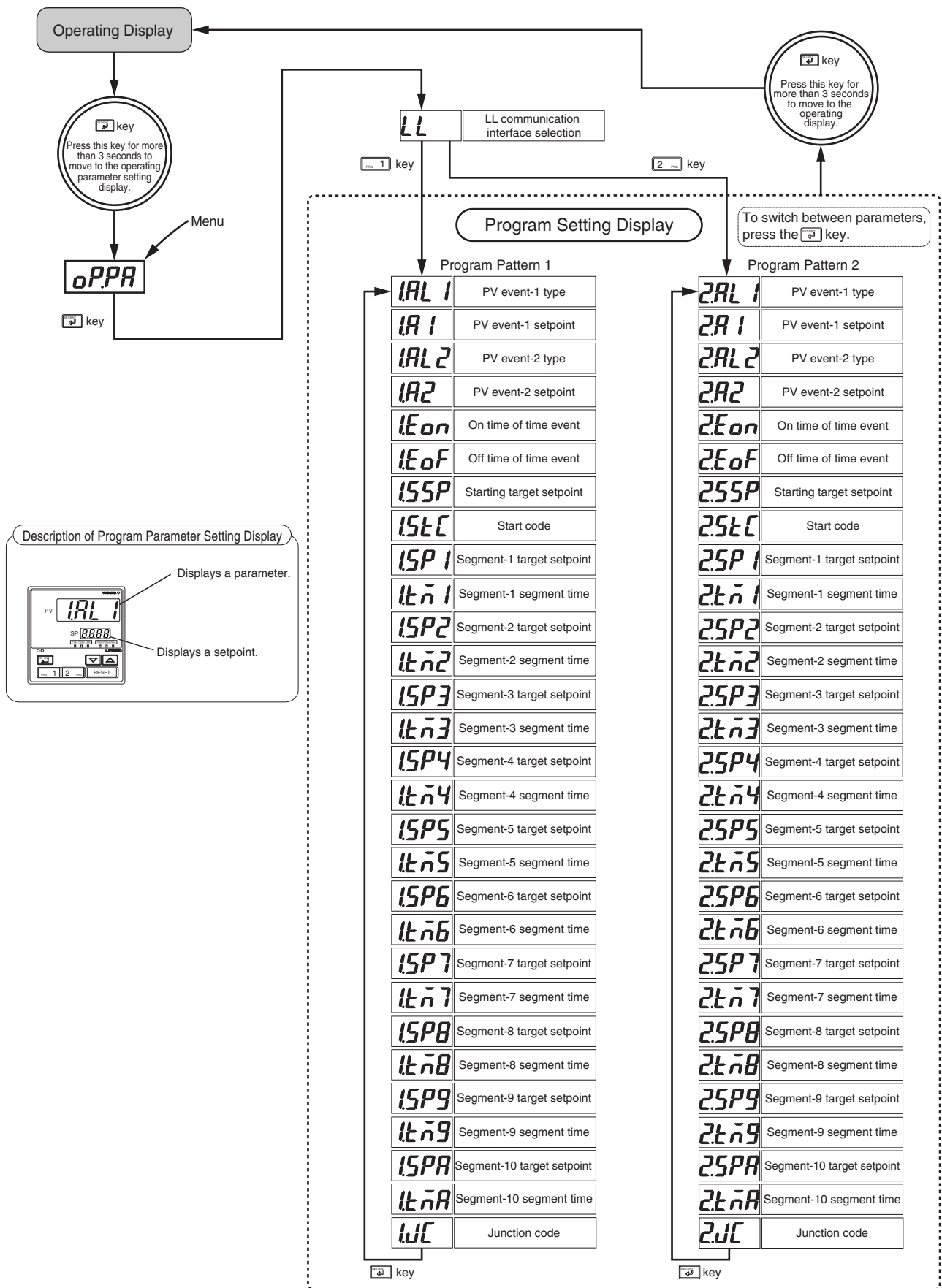

3.6 Lists of Program Parameters

- * Parameters relating to PV or program setpoints should all be set in real numbers. For example, use temperature values to define program setpoints and PV event setpoints for temperature input.
- * The “User Setting” column in the table below is provided for the customer to record setpoints.
- * The “Target Item in CD-ROM” column in the table below provides references from User’s Manual (Reference) (CD-ROM version) which describes items in more detail and items that are not contained in this manual.
- * Number in () is the parameter setpoint that applies when the communication function is used. Ex. OFF(0), ON(1)

● Program-1 Parameters

Parameter Symbol	Name of Parameter	Setting Range and Description	Initial Value	User Setting	Target Item in CD-ROM
IAL1 (1.AL1)	PV event-1 type	OFF(0), 1 to 10 1: PV high limit (energized, no stand-by action) 2: PV low limit (energized, no stand-by action) 3: Deviation high limit (energized, no stand-by action) 4: Deviation low limit (energized, no stand-by action) 5: Deviation high limit (de-energized, no stand-by action) 6: Deviation low limit (de-energized, no stand-by action) 7: Deviation high and low limits (energized, no stand-by action) 8: Deviation within high and low limits (energized, no stand-by action) 9: PV high limit (de-energized, no stand-by action) 10: PV low limit (de-energized, no stand-by action)	OFF(0)		Ref.3.4(5)
IA1 (1.A1)	PV event-1 setpoint	PV alarm: -100.0 to 100.0% of PV input range Deviation alarm: -100.0 to 100.0% of PV input range span Use the “HY1” setup parameter to set the hysteresis of PV event 1.	PV high limit: 0.0% of PV input range. Deviation alarm: 0.0% of PV input range span. Other PV alarms: 0.0% of PV input range.		
IAL2 (1.AL2)	PV event-2 type	OFF(0), 1 to 10 1: PV high limit (energized, no stand-by action) 2: PV low limit (energized, no stand-by action) 3: Deviation high limit (energized, no stand-by action) 4: Deviation low limit (energized, no stand-by action) 5: Deviation high limit (de-energized, no stand-by action) 6: Deviation low limit (de-energized, no stand-by action) 7: Deviation high and low limits (energized, no stand-by action) 8: Deviation within high and low limits (energized, no stand-by action) 9: PV high limit (de-energized, no stand-by action) 10: PV low limit (de-energized, no stand-by action)	OFF(0)		
IA2 (1.A2)	PV event-2 setpoint	PV alarm: -100.0 to 100.0% of PV input range Deviation alarm: -100.0 to 100.0% of PV input range span Use the “HY2” setup parameter to set the hysteresis of PV event 2.	PV high limit: 0.0% of PV input range. Deviation alarm: 0.0% of PV input range span. Other PV alarms: 0.0% of PV input range.		
IEon (1.EON)	On time of Time Event	OFF(-1), 0.00 to 99.59 (hour and minute or minute and second) Use the TMU setup parameter to set the time unit. The time unit is the same as that of the program.	OFF(-1)		Ref.3.4(6)
IEof (1.EOF)	Off time of Time Event	OFF(-1), 0.00 to 99.59 (hour and minute or minute and second) Use the TMU setup parameter to set the time unit. The time unit is the same as that of the program.	OFF(-1)		
ISSP (1.SSP)	Starting target setpoint	0.0 to 100.0% of PV input range	0.0% of PV input range		Ref.5.2(1)
ISTC (1.STC)	Start code	0: Operation begins with the starting target setpoint (1.SSP). 1: Ramp-prioritized PV start 2: Time-prioritized PV start	0		
ISP1 (1.SP1)	Segment-1 target setpoint	0.0 to 100.0% of PV input range	0.0% of PV input range		Ref.5.1(1)

Parameter Symbol	Name of Parameter	Setting Range and Description	Initial Value	User Setting	Target Item in CD-ROM
1E n 1 (1.TM1)	Segment-1 segment time	OFF(-1), 0.00 to 99.59 (hour and minute or minute and second) Ramp setting: OFF, 0.0 to 100.0% of PV input range span (1 hr or 1 min.) Use the TMU setup parameter to set the time unit. The "hour and minute" option in ramp setting means "per hour" and the "minute and second" option means "per minute."	OFF(-1)		Ref.5.1(1)
1SP2 (1.SP2)	Segment-2 target setpoint	0.0 to 100.0% of PV input range	0.0% of PV input range		
1E n 2 (1.TM2)	Segment-2 segment time	OFF(-1), 0.00 to 99.59 (hour and minute or minute and second) Ramp setting: OFF, 0.0 to 100.0% of PV input range span (1 hr or 1 min.)	OFF(-1)		
1SP3 (1.SP3)	Segment-3 target setpoint	0.0 to 100.0% of PV input range	0.0% of PV input range		
1E n 3 (1.TM3)	Segment-3 segment time	OFF(-1), 0.00 to 99.59 (hour and minute or minute and second) Ramp setting: OFF, 0.0 to 100.0% of PV input range span (1 hr or 1 min.)	OFF(-1)		
1SP4 (1.SP4)	Segment-4 target setpoint	0.0 to 100.0% of PV input range	0.0% of PV input range		
1E n 4 (1.TM4)	Segment-4 segment time	OFF(-1), 0.00 to 99.59 (hour and minute or minute and second) Ramp setting: OFF, 0.0 to 100.0% of PV input range span (1 hr or 1 min.)	OFF(-1)		
1SP5 (1.SP5)	Segment-5 target setpoint	0.0 to 100.0% of PV input range	0.0% of PV input range		
1E n 5 (1.TM5)	Segment-5 segment time	OFF(-1), 0.00 to 99.59 (hour and minute or minute and second) Ramp setting: OFF, 0.0 to 100.0% of PV input range span (1 hr or 1 min.)	OFF(-1)		
1SP6 (1.SP6)	Segment-6 target setpoint	0.0 to 100.0% of PV input range	0.0% of PV input range		
1E n 6 (1.TM6)	Segment-6 segment time	OFF(-1), 0.00 to 99.59 (hour and minute or minute and second) Ramp setting: OFF, 0.0 to 100.0% of PV input range span (1 hr or 1 min.)	OFF(-1)		
1SP7 (1.SP7)	Segment-7 target setpoint	0.0 to 100.0% of PV input range	0.0% of PV input range		
1E n 7 (1.TM7)	Segment-7 segment time	OFF(-1), 0.00 to 99.59 (hour and minute or minute and second) Ramp setting: OFF, 0.0 to 100.0% of PV input range span (1 hr or 1 min.)	OFF(-1)		
1SP8 (1.SP8)	Segment-8 target setpoint	0.0 to 100.0% of PV input range	0.0% of PV input range		
1E n 8 (1.TM8)	Segment-8 segment time	OFF(-1), 0.00 to 99.59 (hour and minute or minute and second) Ramp setting: OFF, 0.0 to 100.0% of PV input range span (1 hr or 1 min.)	OFF(-1)		
1SP9 (1.SP9)	Segment-9 target setpoint	0.0 to 100.0% of PV input range	0.0% of PV input range		
1E n 9 (1.TM9)	Segment-9 segment time	OFF(-1), 0.00 to 99.59 (hour and minute or minute and second) Ramp setting: OFF, 0.0 to 100.0% of PV input range span (1 hr or 1 min.)	OFF(-1)		
1SPA (1.SPA)	Segment-10 target setpoint	0.0 to 100.0% of PV input range	0.0% of PV input range		
1E n A (1.TMA)	Segment-10 segment time	OFF(-1), 0.00 to 99.59 (hour and minute or minute and second) Ramp setting: OFF, 0.0 to 100.0% of PV input range span (1 hr or 1 min.)	OFF(-1)		
1JC (1.JC)	Junction code	0: End of resetting 1: End of hold 2: Pattern 1 startup 3: Pattern 2 startup	0		

● Program-2 Parameters

Parameter Symbol	Name of Parameter	Setting Range and Description	Initial Value	User Setting	Target Item in CD-ROM
2AL1 (2.AL1)	PV event-1 type	OFF(0), 1 to 10 1: PV high limit (energized, no stand-by action) 2: PV low limit (energized, no stand-by action) 3: Deviation high limit (energized, no stand-by action) 4: Deviation low limit (energized, no stand-by action) 5: Deviation high limit (de-energized, no stand-by action) 6: Deviation low limit (de-energized, no stand-by action) 7: Deviation high and low limits (energized, no stand-by action) 8: Deviation within high and low limits (energized, no stand-by action) 9: PV high limit (de-energized, no stand-by action) 10: PV low limit (de-energized, no stand-by action)	OFF(0)		Ref.3.4(5)
2A1 (2.A1)	PV event-1 setpoint	PV alarm: -100.0 to 100.0% of PV input range Deviation alarm: -100.0 to 100.0% of PV input range span	PV high limit: 0.0% of PV input range. Deviation alarm: 0.0% of PV input range span. Other PV alarms: 0.0% of PV input range.		
2AL2 (2.AL2)	PV event-2 type	OFF(0), 1 to 10 1: PV high limit (energized, no stand-by action) 2: PV low limit (energized, no stand-by action) 3: Deviation high limit (energized, no stand-by action) 4: Deviation low limit (energized, no stand-by action) 5: Deviation high limit (de-energized, no stand-by action) 6: Deviation low limit (de-energized, no stand-by action) 7: Deviation high and low limits (energized, no stand-by action) 8: Deviation within high and low limits (energized, no stand-by action) 9: PV high limit (de-energized, no stand-by action) 10: PV low limit (de-energized, no stand-by action)	OFF(0)		
2A2 (2.A2)	PV event-2 setpoint	PV alarm: -100.0 to 100.0% of PV input range Deviation alarm: -100.0 to 100.0% of PV input range span	PV high limit: 0.0% of PV input range. Deviation alarm: 0.0% of PV input range span. Other PV alarms: 0.0% of PV input range.		
2Eon (2.EON)	On time of Time Event	OFF(-1), 0.00 to 99.59 (hour and minute or minute and second) Use the TMU setup parameter to set the time unit. The time unit is the same as that of the program.	OFF(-1)		Ref.3.4(6)
2Eof (2.EOF)	Off time of Time Event	OFF(-1), 0.00 to 99.59 (hour and minute or minute and second) Use the setup parameter TMU to set the time unit. The time unit is the same as that of the program.	OFF(-1)		
2SSP (2.SSP)	Starting target setpoint	0.0 to 100.0% of PV input range	0.0% of PV input range		Ref.5.2(1)
2STC (2.STC)	Start code	0: Operation begins with the starting target setpoint (2.SSP). 1: Ramp-prioritized PV start 2: Time-prioritized PV start	0		
2SP1 (2.SP1)	Segment-1 target setpoint	0.0 to 100.0% of PV input range	0.0% of PV input range		Ref.5.1(1)
2TM1 (2.TM1)	Segment-1 segment time	OFF(-1), 0.00 to 99.59 (hour and minute or minute and second) Ramp setting: OFF, 0.0 to 100.0% of PV input range span (1 hr or 1 min.) Use the TMU setup parameter to set the time unit. The "hour and minute" option in ramp setting means "per hour" and the "minute and second" option means "per minute."	OFF(-1)		

Parameter Symbol	Name of Parameter	Setting Range and Description	Initial Value	User Setting	Target Item in CD-ROM
2.5P2 (2.SP2)	Segment-2 target setpoint	0.0 to 100.0% of PV input range	0.0% of PV input range		Ref.5.1(1)
2.6T2 (2.TM2)	Segment-2 segment time	OFF(-1), 0.00 to 99.59 (hour and minute or minute and second) Ramp setting: OFF, 0.0 to 100.0% of PV input range span (1 hr or 1 min.)	OFF(-1)		
2.5P3 (2.SP3)	Segment-3 target setpoint	0.0 to 100.0% of PV input range	0.0% of PV input range		
2.6T3 (2.TM3)	Segment-3 segment time	OFF(-1), 0.00 to 99.59 (hour and minute or minute and second) Ramp setting: OFF, 0.0 to 100.0% of PV input range span (1 hr or 1 min.)	OFF(-1)		
2.5P4 (2.SP4)	Segment-4 target setpoint	0.0 to 100.0% of PV input range	0.0% of PV input range		
2.6T4 (2.TM4)	Segment-4 segment time	OFF(-1), 0.00 to 99.59 (hour and minute or minute and second) Ramp setting: OFF, 0.0 to 100.0% of PV input range span (1 hr or 1 min.)	OFF(-1)		
2.5P5 (2.SP5)	Segment-5 target setpoint	0.0 to 100.0% of PV input range	0.0% of PV input range		
2.6T5 (2.TM5)	Segment-5 segment time	OFF(-1), 0.00 to 99.59 (hour and minute or minute and second) Ramp setting: OFF, 0.0 to 100.0% of PV input range span (1 hr or 1 min.)	OFF(-1)		
2.5P6 (2.SP6)	Segment-6 target setpoint	0.0 to 100.0% of PV input range	0.0% of PV input range		
2.6T6 (2.TM6)	Segment-6 segment time	OFF(-1), 0.00 to 99.59 (hour and minute or minute and second) Ramp setting: OFF, 0.0 to 100.0% of PV input range span (1 hr or 1 min.)	OFF(-1)		
2.5P7 (2.SP7)	Segment-7 target setpoint	0.0 to 100.0% of PV input range	0.0% of PV input range		
2.6T7 (2.TM7)	Segment-7 segment time	OFF(-1), 0.00 to 99.59 (hour and minute or minute and second) Ramp setting: OFF, 0.0 to 100.0% of PV input range span (1 hr or 1 min.)	OFF(-1)		
2.5P8 (2.SP8)	Segment-8 target setpoint	0.0 to 100.0% of PV input range	0.0% of PV input range		
2.6T8 (2.TM8)	Segment-8 segment time	OFF(-1), 0.00 to 99.59 (hour and minute or minute and second) Ramp setting: OFF, 0.0 to 100.0% of PV input range span (1 hr or 1 min.)	OFF(-1)		
2.5P9 (2.SP9)	Segment-9 target setpoint	0.0 to 100.0% of PV input range	0.0% of PV input range		
2.6T9 (2.TM9)	Segment-9 segment time	OFF(-1), 0.00 to 99.59 (hour and minute or minute and second) Ramp setting: OFF, 0.0 to 100.0% of PV input range span (1 hr or 1 min.)	OFF(-1)		
2.5PA (2.SPA)	Segment-10 target setpoint	0.0 to 100.0% of PV input range	0.0% of PV input range		
2.6TA (2.TMA)	Segment-10 segment time	OFF(-1), 0.00 to 99.59 (hour and minute or minute and second) Ramp setting: OFF, 0.0 to 100.0% of PV input range span (1 hr or 1 min.)	OFF(-1)		
2.JC (2.JC)	Junction code	0: End of resetting 1: End of hold 2: Pattern 1 startup 3: Pattern 2 startup	0		

List of PV Event Types

Alarm type	Alarm action "Open/close" shows status of relay contact, and "lit" and "unlit" shows status of lamp	Alarm type code		Alarm type	Alarm action "Open/close" shows status of relay contact, and "lit" and "unlit" shows status of lamp	Alarm type code	
		Contact closes if alarm occurs	Contact opens if alarm occurs			Contact closes if alarm occurs	Contact opens if alarm occurs
No alarm		OFF					
PV high limit		1	/	De-energized on deviation low limit alarm		/	6
PV low limit		2	/	Deviation high and low limits		7	/
Deviation high limit		3	/	Deviation within high and low limits		8	/
Deviation low limit		4	/	De-energized on PV high limit		9	/
De-energized on deviation high limit alarm		/	5	De-energized on PV low limit		10	/

3.7 Explanation of Program Functions

■ Programming

You can create programs using either method 1 or 2 described below.

The controller is factory-set to “method 1”. To create programs using method 2, change the setpoint of the SEG.T (Segment Setting Method) setup parameter to “1”.

Before you begin programming, determine whether your programs are created using the time unit of “hour and minute” or “minute and second.” The controller is factory-set to the “hour and minute” time unit. To create programs using the “minute and second” time unit, change the setpoint of the TMU (Time Unit of Program) setup parameter to “1”.

<Controller Settings>

	Setpoint of SEG.T (Segment Setting Method) Setup Parameter
Time setting (method 1)	0 (factory-set default)
Ramp setting (method 2)	1

Choose the desired method and unit from the two programming methods and time unit options discussed above. Then, create programs according to the chosen options.

1. Creating programs by setting target setpoint and segment time

As shown in the figure below, this method creates programs by setting a segment time and a target setpoint on a segment-by-segment basis.

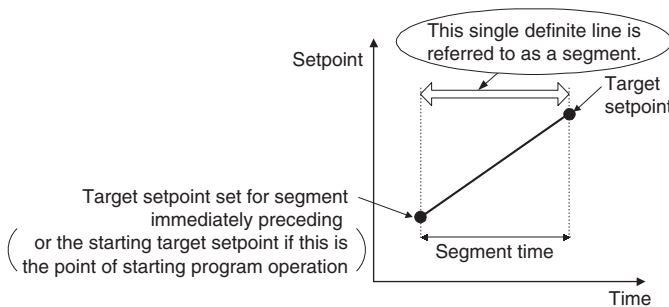

2. Creating programs by setting target setpoint and ramp

As shown in the figure below, this method creates programs by setting a target setpoint and a ramp grade on a segment-by-segment basis.

Define the ramp grade as the amount of change in the setpoint per hour or per minute.

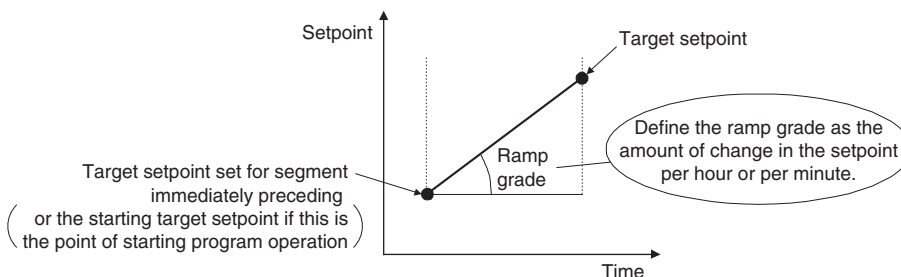

<Controller Settings>

	Setpoint of TMU (Time Unit of Program) Setup Parameter
When changing the setpoint linearly over an hour	0 (factory-set default)
When changing the setpoint linearly over a minute	1

Note: The "Time Unit of Program (TMU)" parameter is the time unit you use when creating programs.

When creating a soak segment during programming, set a time ("hour and minute" or "minute and second") rather than a ramp grade.

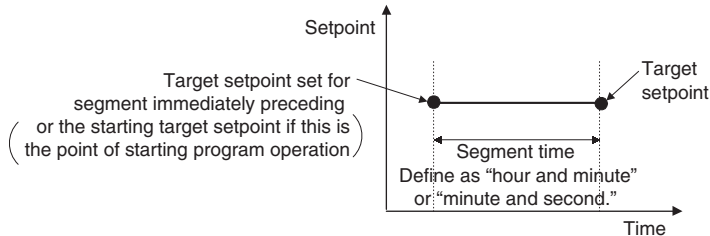

For example, configure segment 1 so the temperature rises in increments of 5°C per minute from 50°C to 100°C, as shown in the figure below.

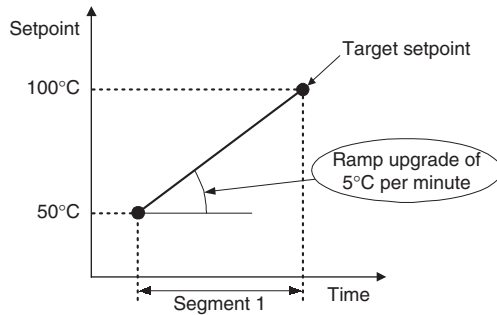

To change the temperature linearly over a minute, set the TMU parameter to "1" (minute and second) before you begin programming.

When programming the controller, set the Segment-1 Segment Time (1.TM1) parameter to 5°C.

This allows the controller to raise the setpoint in increments of 5°C per minute during the interval of segment 1.

■ Controller Behavior at the Start of Program Operation

You can determine how the controller should behave at the start of program operation.

1. Letting the controller run from a starting target setpoint

A starting target setpoint refers to a setpoint from which program operation begins. The controller operates in such a manner that the setpoint changes to the target setpoint over the segment time set for segment 1, irrespective of what the PV value is.

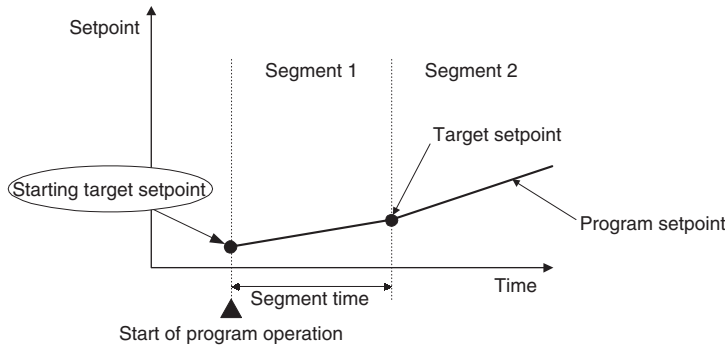

<Controller Settings>

Set the STC (Start Code) program parameter to "0".

2. Letting the controller start from the current PV and run according to time settings defined for segment 1

This method is not available if the SEG.T (Segment Setting Method) parameter is set to "ramp setting."

Starting Point of Operation	Controller Behavior
a	Begins to run from point a according to the time setting defined for segment 1.
b	Begins to run from point b according to the time setting defined for segment 1.
c	Begins to run from point c according to the time setting defined for segment 1.
d	Begins to run from point d according to the time setting defined for segment 1.
e	Begins to run from point e according to the time setting defined for segment 1.

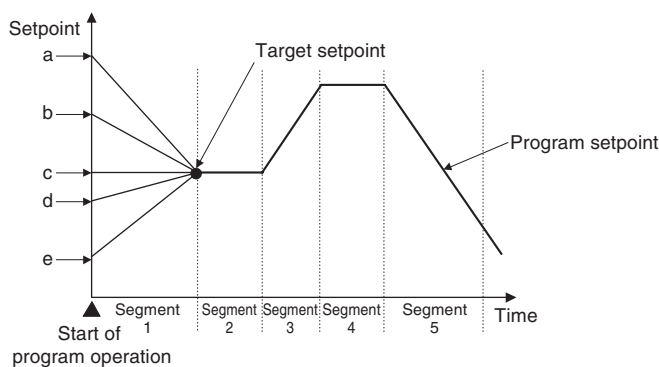

<Controller Settings>

Set the STC (Start Code) program parameter to "2".

3. Letting the controller start from the current PV and run according to ramp settings defined for segment 1

Starting Point of Operation	Controller Behavior
a	Begins to run from point C1 (ignores the time setting defined for segment 1).
b	Begins to run from point C1 (ignores the time setting defined for segment 1).
c	Begins to run from point C1 (ignores the time setting defined for segment 1).
d	Begins to run from point D1 according to the preset ramp setting (the time setting defined for segment 1 is reduced).
e	Begins to run from point E1 according to the preset ramp setting.

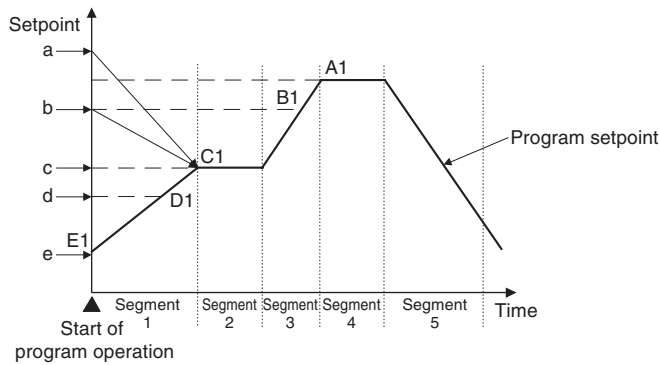

<Controller Settings>

Set the STC (Start Code) program parameter to "1".

■ Program-based Selection of PID Constants

See "■PID Switching (Zone PID)" in "6.2 Lists of Parameters."

■ Program Repetition

Set a program you want to run repetitively in the Junction Code parameter of a program pattern for which the controller is operated.

For example, if you want to run program pattern 1 repetitively, set the Junction Code parameter to "2". This lets the controller repeat program pattern 1 indefinitely.

<Controller Settings>

	Setpoint of JC (Junction Code) Program Parameter
Repetition of program pattern 1	Set the parameter Program Pattern-1 Junction Code (1.JC) to "2".
Repetition of program pattern 2	Set the parameter Program Pattern-2 Junction Code (2.JC) to "3".

■ Program Linking

Use this function to append program pattern 2 to program pattern 1 so the controller runs according to the resulting single program pattern. You can also append program pattern 2 to program pattern 1.

Precautions when Linking Programs

There may be a case that a difference exists between the target setpoint defined for the final segment of a program pattern to be run first and the starting target setpoint of a program pattern to be combined with. If this is the case, a deviation may occur and therefore a derivative action may take place, causing the control output to travel up to 100% or down to 0% and stay at this point.

If program linking is assumed, care must be taken to prevent any significant deviation from arising between the setpoints to be linked when creating programs.

<Controller Settings>

	Setpoint of JC (Junction Code) Program Parameter
To append program pattern 2 to program pattern 1	Set the parameter Program Pattern-1 Junction Code (1.JC) to "3".
To append program pattern 1 to program pattern 2	Set the parameter Program Pattern-2 Junction Code (2.JC) to "2".

■ Retaining the End-of-Program State (End of Hold)

This function keeps the controller in the same state as when the program operation was completed.

When in hold operation, the controller retains its states of control output and event output. To cancel hold operation, use either key operation or external contact input. When the hold operation is cancelled, the control output is set to 0% or OFF, and the event output is set to OFF.

To retain the end-of-program state, set a Junction Code program parameter to "1".

For example, if you want the controller to run according to program pattern 1 and retain the same state as when the program ended, set the Program Pattern-1 Junction Code (1.JC) parameter to "1".

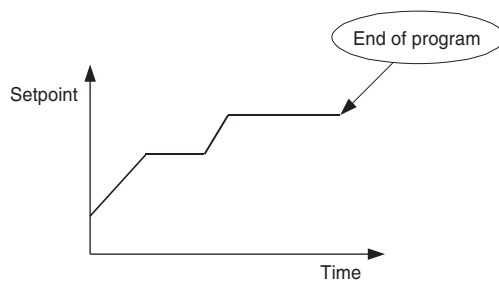

<Controller Settings>

	Setpoint of JC (Junction Code) Program Parameter
To quit hold operation in program pattern 1	Set the parameter Program Pattern-1 Junction Code (1.JC) to "1".
To quit hold operation in program pattern 2	Set the parameter Program Pattern-2 Junction Code (2.JC) to "1".

■ Suspending the Progress of a Program (Wait Function)

When a running program moves from one segment to another, the wait function places the program in a wait (stand-by) state, by using a wait zone and a wait time, until any deviation is cancelled.

The wait function works only when the program moves from a ramp segment (either up-grade or downgrade) to a soak segment (where the setpoint is kept constant).

A wait zone is a deviation bandwidth from which the degree of PV input tracking is judged.

A wait time is the length of time that elapses until the PV input enters the wait zone. The program progresses if the PV input fails to re-enter the wait zone within the wait time.

When the program is in the wait state, the time setpoints of Segment Time and Time Event parameters temporarily cease to be passed. At this point, the output based on the Time Event parameter is retained.

● If the PV Input Reaches the Wait Zone before the Wait Time Expires

If the PV input re-enters the wait zone after the start of wait action and before the expiry of the wait time, the program changes from a wait state to a run state and begins to progress.

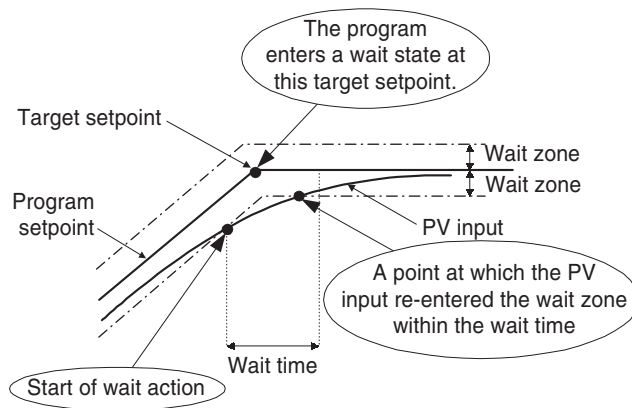

● If the PV Input Reaches the Wait Zone after the Wait Time Expires

If the PV input re-enters the wait zone after the start of wait action and after the expiry of the wait time, the program changes from a wait state to a run state at the point where the wait time has passed, and begins to progress.

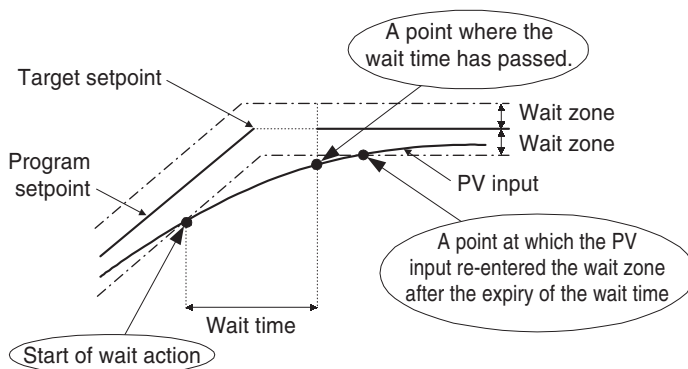

<Controller Settings>

Setpoint of WIT.Z (Wait Zone) operating parameter	OFF, 1.0 to 10.0% of PV input range span
Setpoint of WIT.T (Wait Time) operating parameter	OFF, 0.00 to 99.59 ("hour and minute" or "minute and second") The time unit is the same as that specified in the TMU (Time Unit of Program) setup parameter.

3.8 Program Pattern Setup Charts

See “3.1 Overview of Program Patterns” and “3.2 Example of Program Pattern Setup Charts” for details on how to use the setting charts.

There are two identical charts shown below because two programs can be registered with the UP351.

Fill in the fields with bold-face borders in the order of steps 1 to 10, as shown below. Then, input these setup data items to the UP351.

1. Maximum value of PV input range: Setpoint of the “Maximum Value of PV Input Range (RH)” setup parameter
2. Minimum value of PV input range: Setpoint of the “Minimum Value of PV Input Range (RL)” setup parameter
3. PV input unit: Setpoint of the “PV Input Unit (UNIT)” setup parameter
4. Program time unit: Setpoint of the “Program Time Unit (TMU)” setup parameter
5. Segment setting method: Setpoint of the “Segment Setting Method (SEG.T)” setup parameter
6. Starting target setpoint: Setpoint of the “Starting Target Setpoint (SSP)” program parameter
7. Start code: Setpoint of the “Start Code (STC)” program parameter
8. Junction code: Setpoint of the “Junction Code (JC)” program parameter
9. Target setpoint, Segment time, PV events 1 and 2, and Time event: Setpoint of each program parameter
10. Draw the program pattern.

System name			
Program No.		Program time unit (TMU)	4
Program name		Segment setting method (SEG.T)	5
Model	UP351 -	Starting target setpoint (SSP)	6
Serial No.		Start code (STC)	7
		Junction code (JC)	8

Unit 3

Maximum value of PV input range (RH) 1
100%

Minimum value of PV input range (RL) 2
0%

10

	1	2	3	4	5	6	7	8	9	10
Segment No.										
Target setpoint (SP)										
Segment time (TM)										
PV event 1	Event type (AL1)									
	Event setpoint (A1)									
PV event 2	Event type (AL2)									
	Event setpoint (A2)									
Time event	On time of time event (EON)									
	Off time of time event (EOF)									

System name	
Program No.	
Program name	
Model	UP351 -
Serial No.	

Program time unit (TMU)	4
Segment setting method (SEG.T)	5

Starting target setpoint (SSP)	6
Start code (STC)	7
Junction code (JC)	8

Unit	3										
Maximum value of PV input range (RH)	1	10									
	100%										
Minimum value of PV input range (RL)	2										
	0%										

9	Segment No.	1	2	3	4	5	6	7	8	9	10	
	Target setpoint (SP)											
	Segment time (TM)											
	PV event 1	Event type (AL1)										
		Event setpoint (A1)										
	PV event 2	Event type (AL2)										
		Event setpoint (A2)										
	Time event	On time of time event (EON)										
		Off time of time event (EOF)										

Blank Page

4. Operations

This chapter describes key entries for operating the controller. For operations using external contact inputs, see “1.5 Terminal Wiring Diagrams.” If you cannot remember how to carry out an operation during setting, press the  key for more than 3 seconds. This brings you to the display (operating display) that appears at power-on.

NOTE

Do not use the instrument generating strong magnetic field such as radio equipment and the like near the controller. This may cause the fluctuation of the PV value.

4.1 Monitoring-purpose Operating Displays Available during Operation

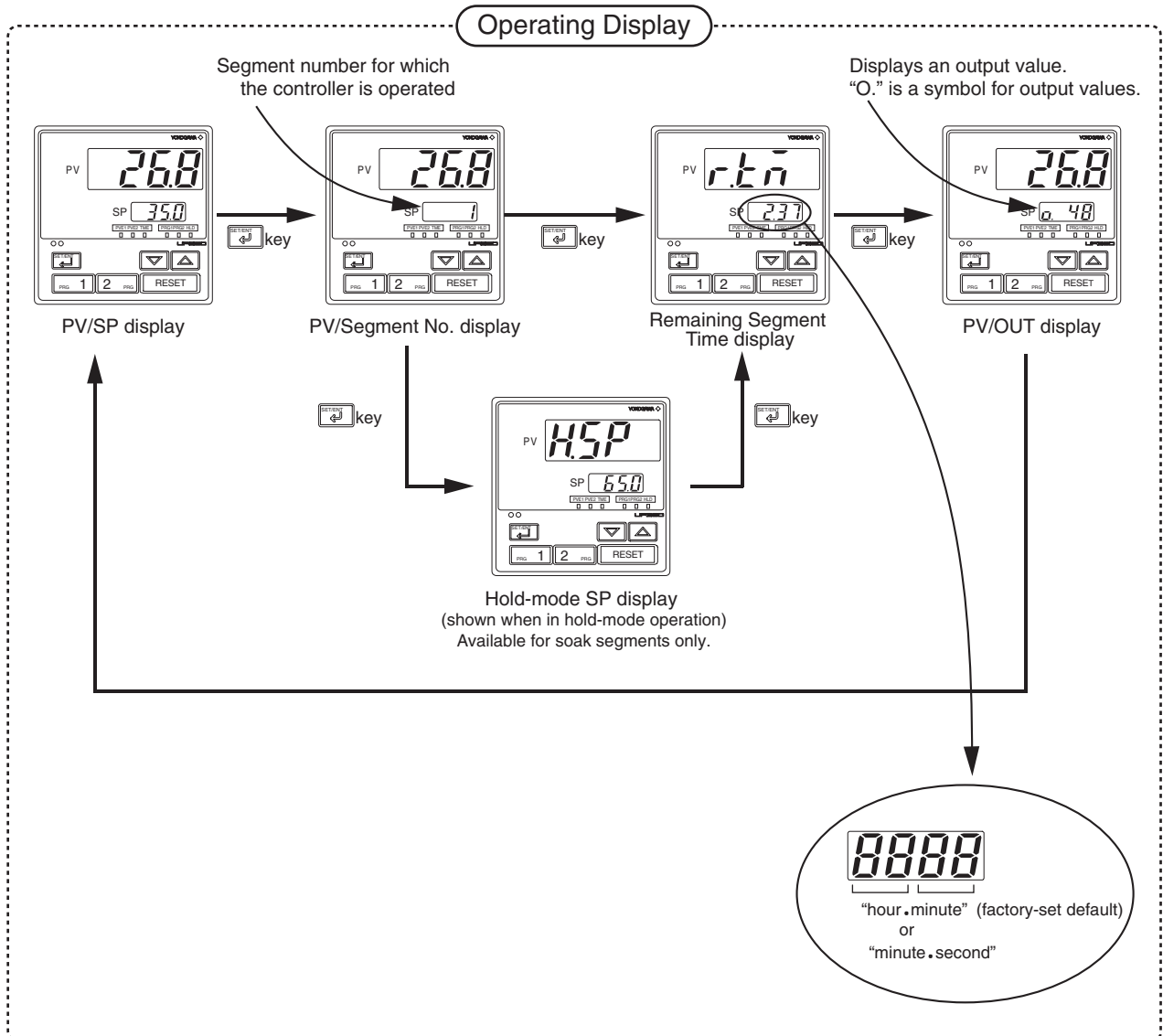

4.2 Performing/Canceling Auto-tuning

Perform auto-tuning when you have finished creating program patterns. Make sure the controller is in Run state (PRG) before carrying out auto-tuning. See “4.4 Starting (PRG)/ Stopping (RESET) the Controller,” to change to PRG.

PID constants are obtained by using the current program setpoint value at the start of auto-tuning.

NOTE

When on-off control is being used, auto-tuning cannot be carried out. Moreover, do not perform auto-tuning when controlling any of the following processes.

- Control processes with quick response such as flow control or pressure control
- Processes where even temporary output on/off results in inconvenience
- Processes where a large output change at control element results in inconvenience
- Processes where variations in PV may exceed an allowable range, adversely affecting product quality

1. Bring the operating display into view (display appears at power on).

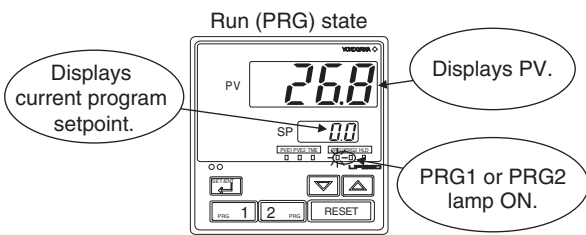

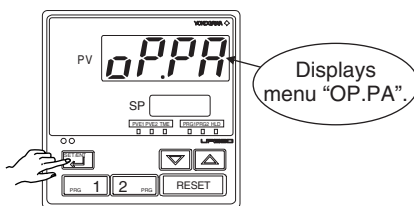

2. Press the  key for more than 3 seconds to call up the menu “QPA”.



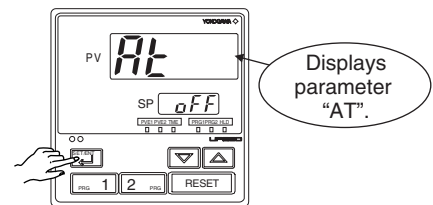

3. Press the  key several times to display the parameter “AT”.

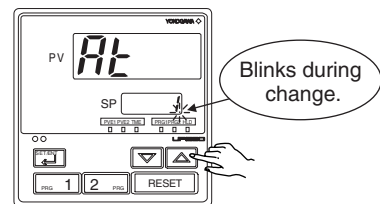

4. Press the  or  key to display the required setpoint. Set as 'TA= 1' to perform auto-tuning for the first group of PID constants.



To cancel auto-tuning, seAT = OFF.

- Press the  key once to register the setpoint. (This starts auto-tuning.)
If the  key is pressed when AT = OFF, auto-tuning will be cancelled. In this case, PID contains the value existing before auto-tuning.
After cancellation, the controller enters the Stop (RESET) state.

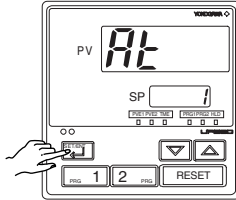

- During auto-tuning, the panel indications become as shown below

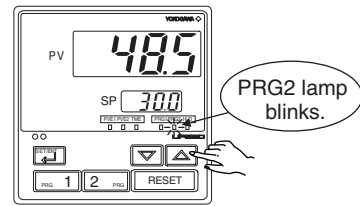

Auto-tuning is complete when the PRG2 lamp goes out.

4.3 Setting PID Manually

If you know the values to be set or if suitable PID constants cannot be obtained by auto-tuning, follow the procedure below to set values.

- Bring the operating display into view (display appears at power on).

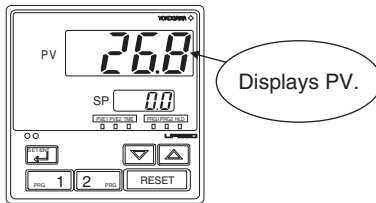

- Press the  key for more than 3 seconds to call up the menu "OPA".

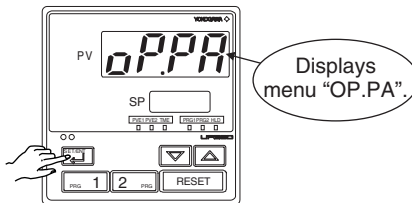

- Press the  key several times to display the parameter "PID".

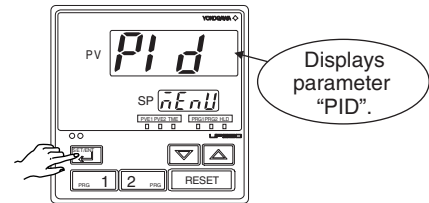

- Press the  key once to display "1Gr".

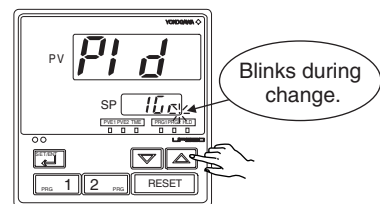

5. Press the  key once to register the setpoints.

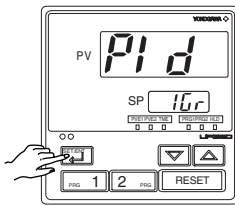

6. Press the  key once to display the parameter "1.P".

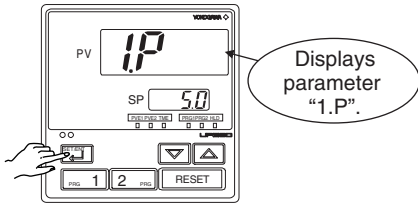

7. Press the  or  key to display the required setpoint.

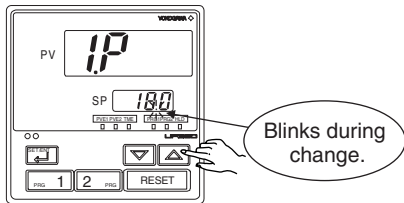

8. Press the  key once to register the setpoint.

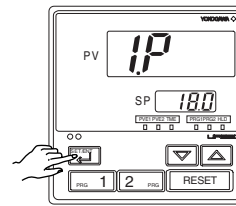

The same steps can be used for integral time (1.I) and derivative time (1.D) that are displayed after this.

[TIP]

The PID parameter numbers set in step 4. should be set as follows:

- In case of PID group 1, PID = 1Gr
- In case of PID group 2, PID = 2Gr
- In case of PID group 3, PID = 3Gr
- In case of PID group 4, PID = 4Gr

9. Press the  key for more than 3 seconds. This returns you to the display shown at power-on (figure below).

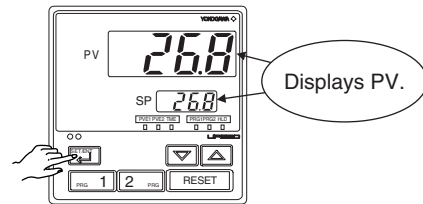

4.4 Starting (PRG)/Stopping (RESET) the Controller

The following operating procedure starts program operation.

1. Bring the operating display into view (appears at power-on).

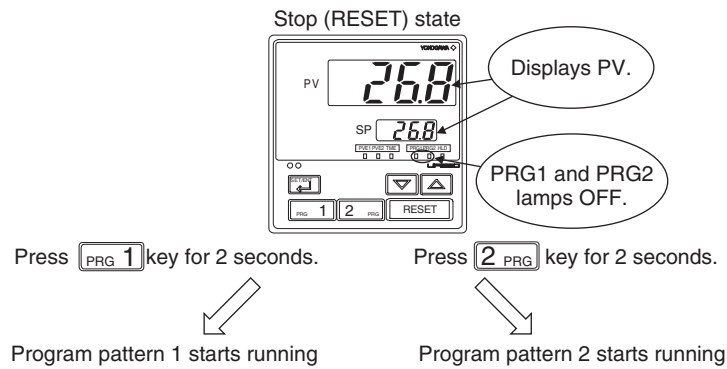

2. Press the [PRG 1] key for more than 2 seconds to start program pattern 1.

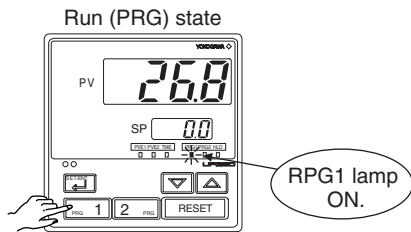

2. Press the [2 PRG] key for more than 2 seconds to start program pattern 2.

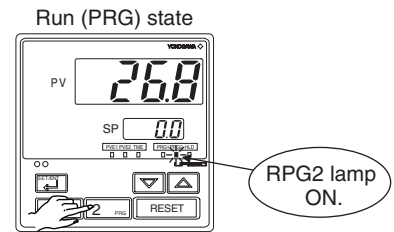

3. To stop program operation, press the [RESET] key for more than 2 seconds.

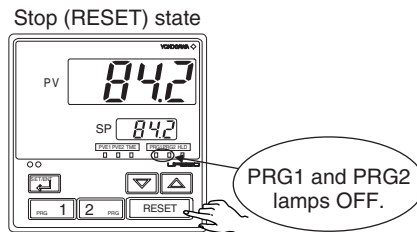

When in the RESET state, the controller provides the following input/output values.

PV input	Value of process variable
Control output	Preset output value (factory-set to 0%)
Event output	OFF

■ Diagram of Operating State Transition

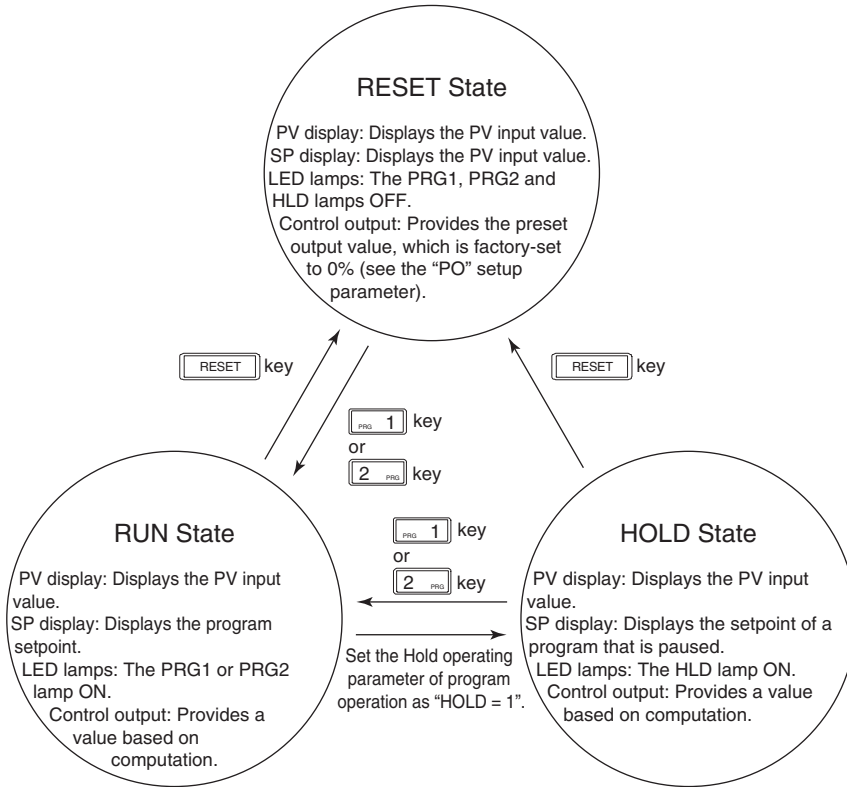

4.5 Enabling/Disabling Hold Mode of Program Operation

The following operating procedure brings program pattern 1 into a pause during operation. This procedure also applies to program pattern 2.

NOTE

If a contact input is on (hold mode is set) when the hold mode is enabled and disabled with the input, the mode cannot be cancelled by key operation.

- 1. Bring the operating display into view (appears at power-on).

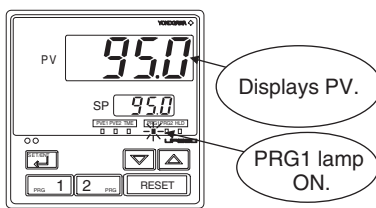

- 2. Press the  key for more than 3 seconds to call up the menu "OPA".

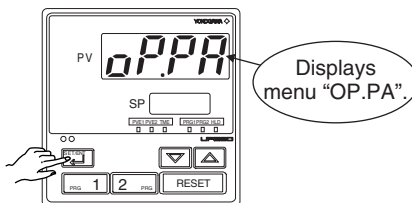

- 3. Press the  key three times to display the parameter "HOLD".

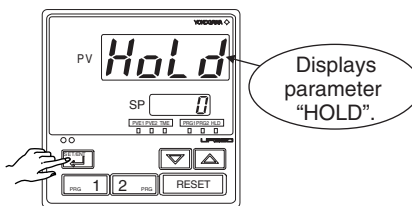

- 4. Press the  key once to display "1".

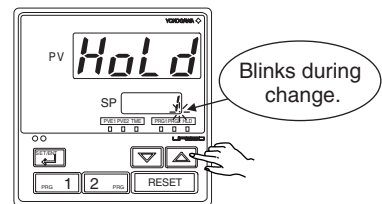

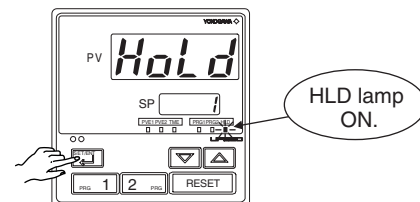

To cancel the hold mode, set as "HOLD = 0".

- 5. Press the  key once to register the setpoint. The HLD lamp ON and the controller under program operation comes to a pause.

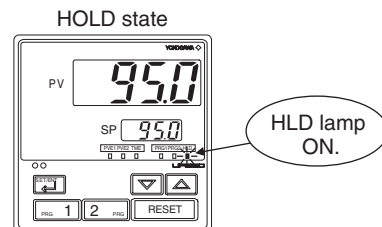

The controller automatically returns to the display shown at power-on (figure below).



If you have cancelled the hold mode, press the  key for more than 3 seconds to return to the display shown at power-on.

4.6 Changing Program Setpoints when in Hold Mode

The following operating procedure changes program setpoints when program operation is put in hold mode.

Before changing program setpoints, enable the hold mode of program operation as instructed in "4.5 Enabling/Disabling the Hold Mode of Program Operation." When you have finished changing the setpoints, cancel the hold mode. The controller continues program operation using the new setpoints. Note however, that the new setpoints are not incorporated in any previously created program pattern.

NOTE

Program setpoints that can be changed during the hold mode are limited only to those of a soak segment (i.e., a segment with invariable program setpoints). It is not possible to change the program setpoints of any ramp segment (a segment whose program setpoints vary with time).

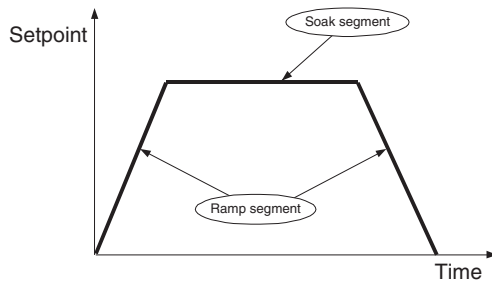

1. Bring the Hold-mode operating display into view (appears at power-on).

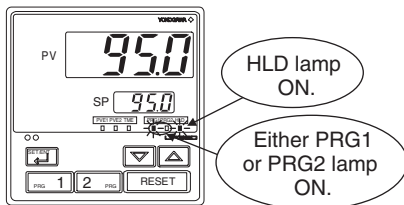

2. Press the  key twice to display HOLD SP display

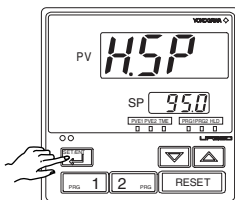

3. Press the  or  key to display the required setpoint.

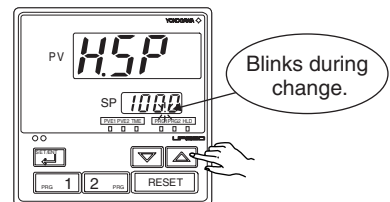

4. Press the  key once to register the setpoint.

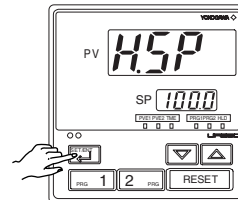

4.7 Executing “Advance” Function

The following operating procedure advances a segment or segments during program operation.

1. Bring the operating display into view (appears at power-on).

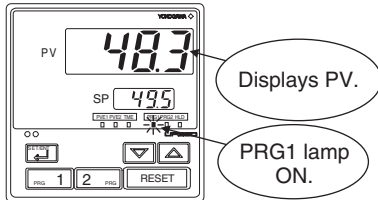

2. Press the key for more than 3 seconds to call up the menu “OP.PA”.

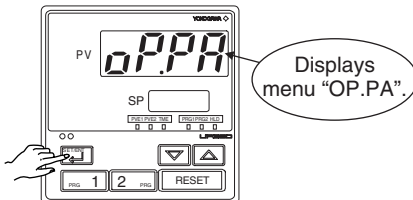

3. Press the key twice to display the parameter “ADV”.

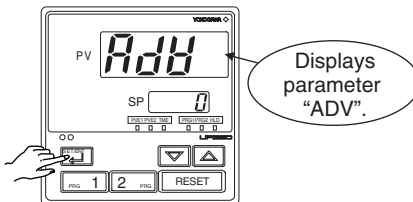

4. Press the key once to display “1”.

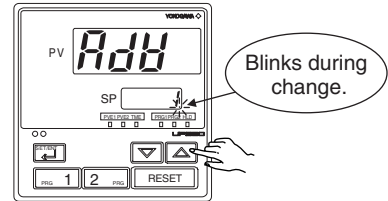

5. Press the key once to register the setpoint.

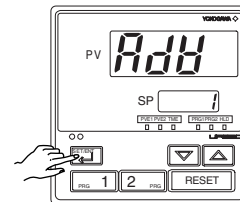

The controller automatically returns to the display shown at power-on (figure below).

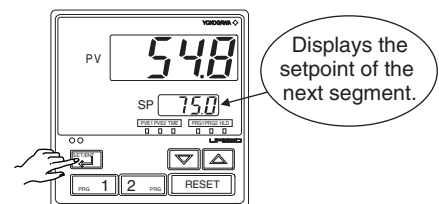

Blank Page

5. Troubleshooting and Maintenance

5.1 Troubleshooting

■ Troubleshooting Flow

If the operating display does not appear after turning on the controller's power, follow the measures in the procedure below.

If a problem appears complicated, contact our sales representative.

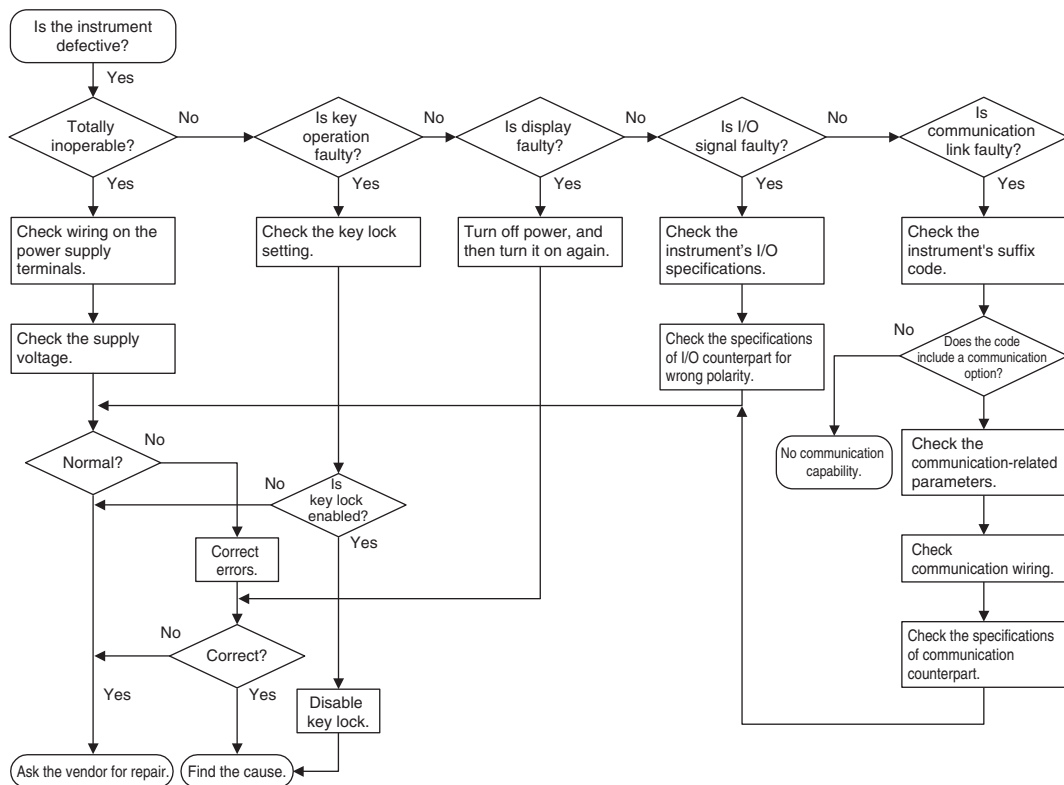

IMPORTANT

Take note of the parameter settings when asking the vendor for repair.

■ Errors at Power on

The following table shows errors that may be detected by the fault diagnosis function when the power is turned on.

Error indication (on PV display unit)	Description of error	PV	Control output	Event output	Retransmission output	Communication	Remedy
<i>E000</i> (E000)	Faulty RAM	None	0% or less or OFF	OFF	0% or less	Stopped	Faulty Contact us for repair.
<i>E001</i> (E001)	Faulty ROM				0%		
<i>E002</i> (E002)	System data error	0%			0%		
PV decimal point blinks.	Faulty calibration value	Normal action (out of accuracy)	Normal action (out of accuracy)	Normal action (out of accuracy)	Normal action (out of accuracy)	Normal action	Check and set the parameters, as they have been set to the limited values.
<i>E400</i> (E400)	Parameter error	0%	Preset value	OFF	0%		

■ Possible Errors during Operation

The following shows possible errors occurring during operations.

Error indication (on PV display unit)	Description of error	PV	Control output	Event output	Retransmission output	Communication	Remedy
Displays "RJC" and PV alternately	RJC error	Measured with RJC=OFF	Normal action	Normal action	Normal action	Normal action	Faulty Contact us for repair.
PV value blinks.	EEPROM error	Normal action	Normal action	Normal action	Normal action	Normal action	Faulty Contact us for repair.
<i>E300</i> (E300)	A/DC error	105%	Preset value	Normal action	Normal action	Normal action	
<i>b.o.u.t</i> (B.OUT)	PV burnout error	Dependent on the BSL parameter Up-scale: 105% Down-scale: -5%	Preset value	Normal action	Normal action	Normal action	Check wires and sensor.
<i>o.v.e.r</i> (OVER) or <i>-o.v.e.r</i> (-OVER)	Excessive PV Out of -5 to 105%	-5% or 105%	Normal action	Normal action	Normal action	Normal action	Check process.
<i>E200</i> (E200)	Auto-tuning failure (Time-out)	Normal action	Normal action	Normal action	Normal action	Normal action	Check process. Press any key to erase error indication.
Decimal point on setpoint display blinks. (on setpoint display unit)	Faulty communication line	Normal action	Normal action	Normal action	Normal action	Normal action	Check wires and communication parameters, and make resetting. Recovery at normal receipt
All indications off	Runaway (due to defective power or noise)	None	0% or less or OFF	OFF	0% or less	Stopped	Faulty if power off/on does not reset start the unit. Contact us for repair.
All indications off	Power off	None	0%	OFF	0%	Stopped	Check for abnormal power.

■ If a Power Failure Occurs during Operation

● Momentary power failures shorter than 20 ms

The controller is not affected at all and continues normal operation.

● Power failures of 20 ms or longer

- Setting parameters that have already been configured retain their settings.
- Auto-tuning is cancelled.
- After recovery from a power failure, program operation is stopped. The control output begins with the preset output value.
- Event output is OFF.

5.2 Maintenance

This section describes the cleaning and maintenance of the UP351.

5.2.1 Cleaning

The front panel and operation keys should be gently wiped with a dry cloth.



NOTE

Do not use alcohol, benzine, or any other solvents.

5.2.2 Replacing Brackets

When the brackets are broken or lost, purchase the following brackets for replacement.

Target Model	Part No.	Sales Unit
UP351	T9115NL	A large bracket and small bracket in pair

SEE ALSO

“1.2 How to Install,” for how to replace brackets.

5.2.3 Attaching Terminal Cover

When a terminal cover is necessary, purchase the following part.

Tareget Model	Part No.	Sales Unit
UP351	T9115YD	1

■ Attaching Terminal Cover

The procedure for attaching the terminal cover is as follows.



Do not touch the terminals on the rear panel when power is being supplied to the controller. Doing so may result in electric shock.

Before attaching the terminal cover, turn off the source circuit breaker and use a tester to check that the power cable is not conducting any electricity.

1. Before attaching the terminal cover, fold it once or twice so that the side which has the "Handle With Care" symbol (⚠), is on the outside.

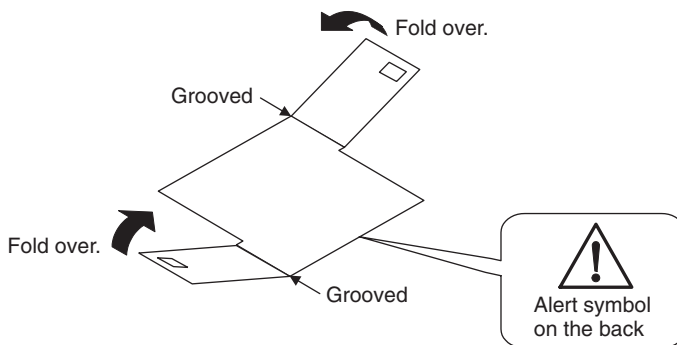

Folding Direction of Terminal Cover



Do not fold the terminal cover the wrong way, doing so not only reduces the cover's strength but may also cause the hinge to crack, thereby disabling attachment.

2. With the cover properly folded, fit its top and bottom holes to the protrusions of the mounting brackets.

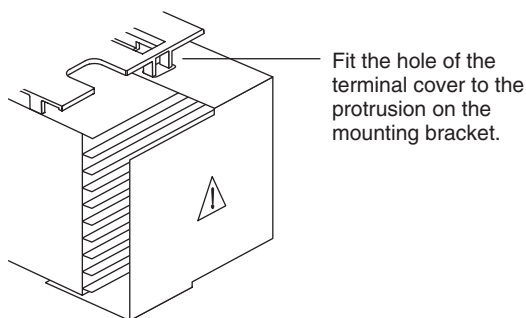

Attaching Terminal Cover

5.2.4 Replacing Parts with a Limited Service Life

The following UP351 parts have a limited service life.

The service life given in the table assume that the controller is used under normal operating conditions.

Part	Service life
Aluminum electrolytic condenser	About 10 years (rated)
EEPROM	About 100,000 times of writings
Alarm output relays	About 100,000 more ON-OFF operations or with resistance load
Control output relays	About 100,000 more ON-OFF operations or with resistance load

If any of these parts, except control output relays, cause a controller failure due to deterioration, contact your dealer for replacement at your cost.

SEE ALSO

“5.2.5 Replacing Control Output Relays,” for how to replace the control output relays.

5.2.5 Replacing Control Output Relays

This subsection describes how to replace the control output relays.

Since inspection is needed in case parts are replacement will be carried out by a YOKOGAWA engineer or an engineer certified by YOKOGAWA. When replacement is required, contact your nearest YOKOGAWA dealer.



Always turn off the power before starting the work in order to avoid electric shock.

Do not pull out the internal unit for any other purpose other than to replace the control output relays.

1. Insert a flat-blade screwdriver (tip width of 6 mm is recommended) into the opening with the tip in parallel with the front panel, and then turn the screwdriver gently this procedure to four openings 1, 2, 3 and 4 (see the figure below) on the upper and lower parts of the bezel, in order. The bezel slightly moves forward from the housing.

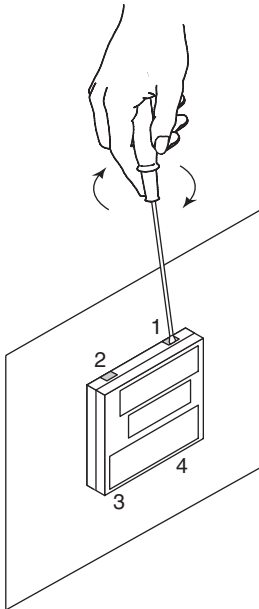

2. Push up the center of the bottom gasket of bezel by a finger to release the latch.

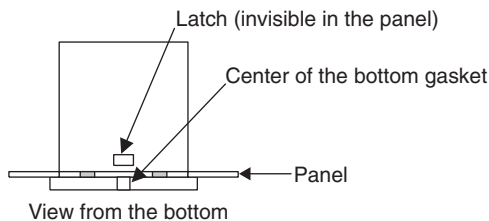

3. Insert the screwdriver into the four openings and flip the tip forward to move the bezel more forward.
4. Hold the bezel and pull it along with the internal unit out of the housing.
(Note) Be careful not to damage the RJC sensor

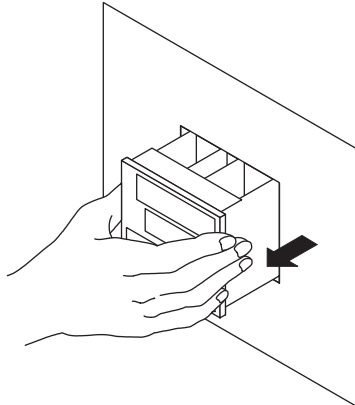

5. The location and number of the relays differ depending on the model code of the UP351. Confirm the location of the control output relay to be replaced before pulling out the relay.

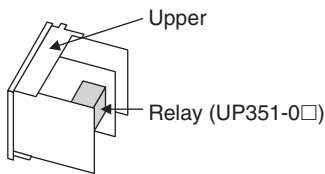

6. Pull out the relay to be replaced.
The control output relays are easy to remove and mount, since they are connected via a socket onto the print boards.

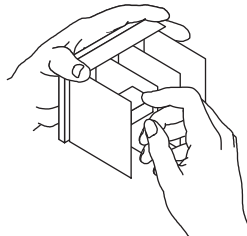

Insert the new relay in the socket. Use the following relay

Manufacturer	OMRON
Model	G6B-2114P-FD-US-P6B
Power supply	12 V DC

- 7. Insert the internal unit into the housing.**
Apply power to the controller and confirm that the initial operating display is shown. If the operating display is not shown properly, turn off the controller and pull out the internal unit. Then, insert it into the housing again.

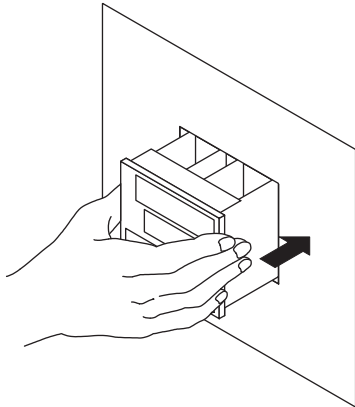

This completes replacement of the control output relay.

Blank Page

6. Parameters

This chapter contains a parameter map as a guideline for setting parameters, and lists of parameters for recording User Settings.

6.1 Parameter Map

UP351 Parameter Map

Operating Display

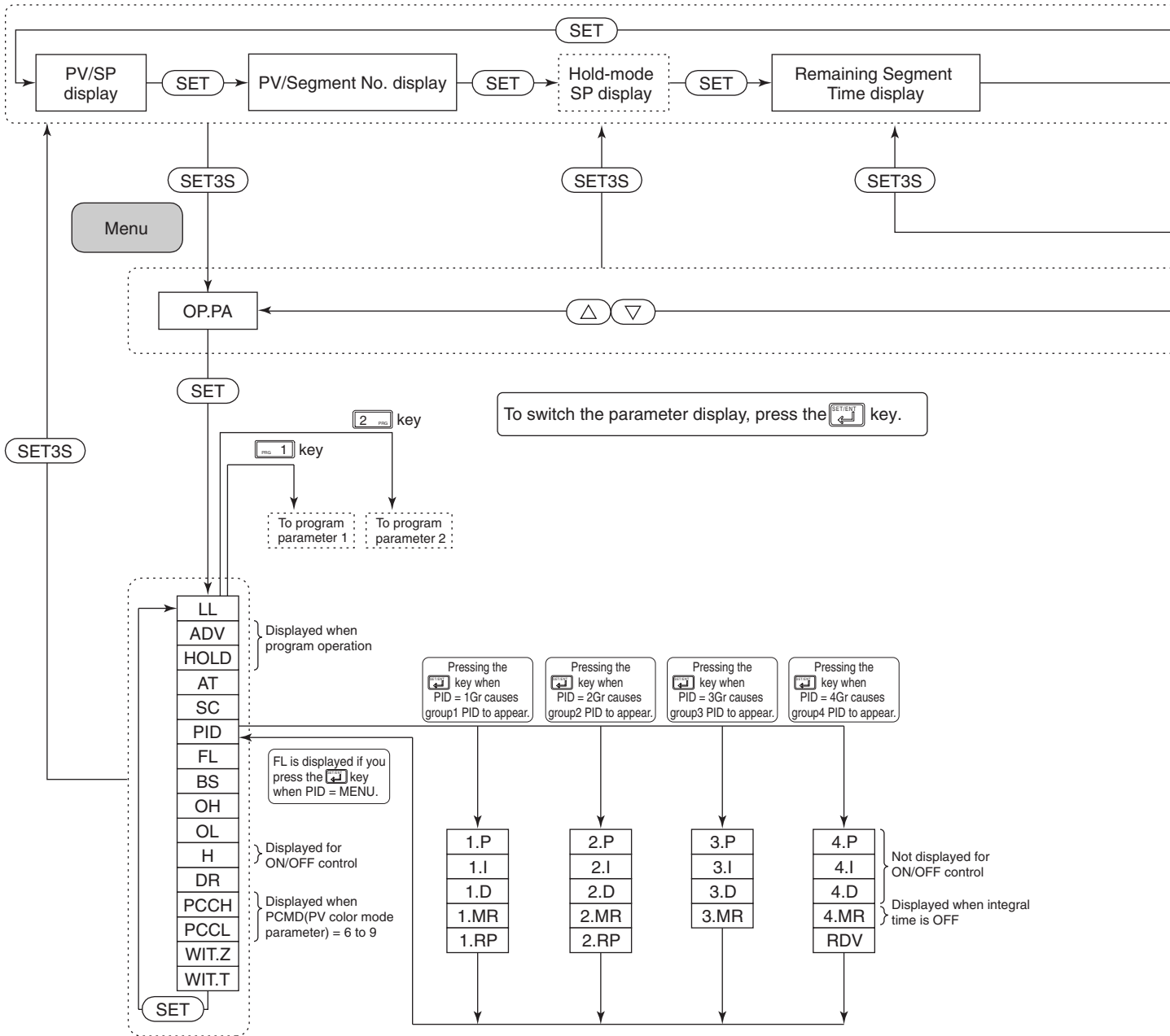

NOTE

Changing the registered value of a setup parameter may cause the registered value of an operating parameter to be initialized automatically. Thus, when you have changed a setup parameter, always check that the registered value of the operating parameter is appropriate. If it is initialized to default, reset it to the required value.

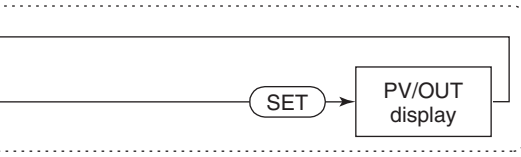

(SET) : Press the key once.
 (SET3S) : Press the key for 3 seconds.
 (Δ) (▽) : Press the or key once.

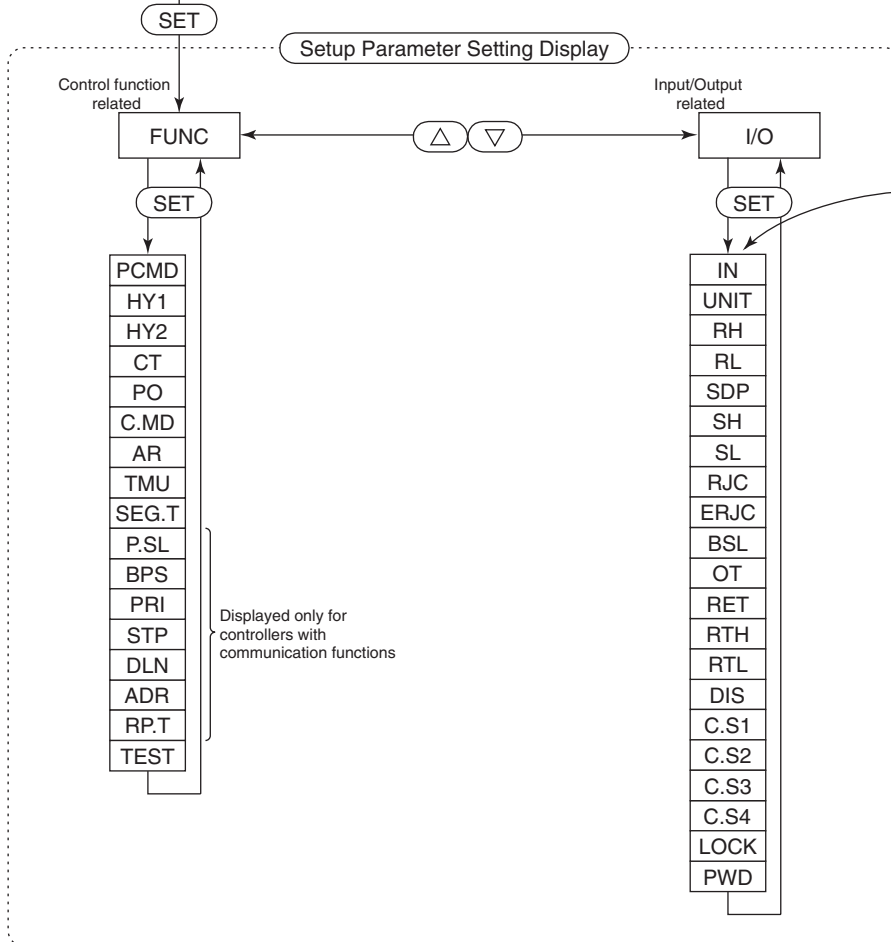
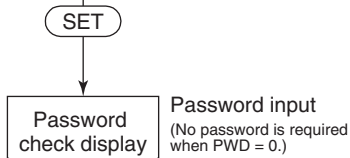
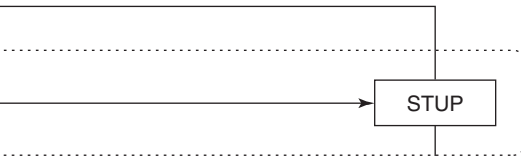

6.2 Lists of Parameters

- * Parameters relating to PV or program setpoints should all be set in real numbers. For example, use temperature values to define program setpoints and PV event setpoints for temperature input.
- * The “User Setting” column in the table is provided for the customer to record setpoints.
- * The column “Target Item in CD-ROM” in the table provides references from User’s Manual (Reference) (CD-ROM version) which describes items in more detail and items that are not contained in this manual.
- * Numbers in () are the parameter setpoints that apply when the communication function is used. ex. OFF (0), ON (1)

■ Operating Parameters

Parameter Symbol	Name of Parameter	Setting Range and Description	Initial Value	User Setting	Target Item in CD-ROM
LL (LL)	LL communication interface selection	OFF (0): Communication is carried out via the RS485 communication terminals. ON (1): Communication is carried out via the light-loader adapter.	With communication:OFF (0) Without communication:ON(1)		—
Adv (ADV)	Advance of segment	This parameter appears during program operation. 0: OFF 1: Execute “Advance” (segments are skipped)	0		Ref.5.2(7)
Hold (HOLD)	Hold of program operation	This parameter appears during program operation. 0: OFF 1: Pause (Hold)	0		Ref.5.2(3) Ref.5.2(5)
At (AT)	Auto-tuning	OFF (0): No auto-tuning 1: Auto-tuning for PID group 1 2: Auto-tuning for PID group 2 3: Auto-tuning for PID group 3 4: Auto-tuning for PID group 4 AUTO (5): Performs auto-tuning to all groups 1 to 4.	OFF (0)		—
SC (SC)	“Super” function	OFF (0): Disable 1: Overshoot suppressing function Suppresses overshoots generated by abrupt changes in the target setpoint or by disturbances. 2: Hunting suppressing function (Stable mode) Suitable to stabilize the state of control when the load varies greatly, or the target setpoint is changed. Enables to answer the wider characteristic changes compared with Response mode. 3: Hunting suppressing function (Response mode) Enables quick follow-up and short converging time of PV for the changed target setpoint. Note: Use “SUPER” function (SC) 2 or 3 in PID control or PI control. “SUPER” function 2 or 3 is not available in the following controls: 1) ON/OFF control 2) P control (control for proportional band only) 3) PD control (control for proportional band and derivative item only) 4) Heating/cooling control Do not use hunting suppressing function when control processes with response such as flow or pressure control.	OFF (0)		Ref.2.1(5) Ref.2.1(6)
PI d (PID)	PID parameter display number	MENU (0): Move to FL parameter display 1Gr (1) to 4Gr (4): Display of each PID parameter	MENU (0)		Ref.5.1(2)
FL (FL)	PV input filter	OFF (0), 1 to 120 sec. Used when the PV input fluctuates.	OFF (0)		Ref.1.1(1)
BS (BS)	PV input bias	-100.0% to 100.0% of PV input range span Used to correct the PV input range.	0.0% of PV input range span		
OH (OH)	Output high limit	-5.0 to 105.0% (OL < OH)	100%		Ref.2.1(3)
OL (OL)	Output low limit	-5.0 to 105.0% (OL < OH)	0.0%		

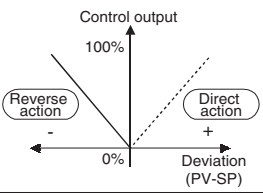
Parameter Symbol	Name of Parameter	Setting Range and Description	Initial Value	User Setting	Target Item in CD-ROM
H (H)	ON/OFF control hysteresis	In ON/OFF control: 0.0 to 100.0% of PV input range span	ON/OFF control: 0.5% of PV input range span		—
dr (DR)	Direct/reverse action switching	0: reverse action, 1: direct action 	0		Ref.2.1(1)
PCCH (PCCH)	High limit for PV color change	When PCMD (PV color mode parameter) = 6 or 7 : -100.0 to 100.0 % of PV input range When PCMD (PV color mode parameter) = 8 or 9 : -100.0 to 100.0 % of PV input range	When PCMD = 6 or 7 : PCCH = 100.0%, PCCL = 0.0 % When PCMD = 8 or 9 : PCCH and PCCL = 1.0 %		—
PCCL (PCCL)	Low limit for PV color change				
WIT.Z (WIT.Z)	Wait zone	OFF (0), 1.0 to 10.0% of PV input range span	OFF (0)		Ref.5.2(4)
WIT.T (WIT.T)	Wait time	0.00 to 99.59 ("hour and minute" or "minute and second") The unit is the same as that set in the Time Unit of Program (TMU) parameter.	0.00		

● PID-related Parameters

The following parameters are displayed when "1Gr" is set to PID parameter display number (PID).

To set PID parameters corresponding to 2 to 4, set "2Gr", "3Gr", or "4Gr" to PID. The relevant parameters will then be displayed.

Parameter Symbol	Name of Parameter	Setting Range and Description	Initial Value	User Setting	Target Item in CD-ROM
1P (1.P)	Proportional band	0.1 to 999.9%	5.0%		—
1I (1.I)	Integral time	OFF (0), 1 to 6000 sec.	240 sec.		—
1D (1.D)	Derivative time	OFF (0), 1 to 6000 sec.	60 sec.		—
1MR (1.MR)	Manual reset	-5.0 to 105.0% (enabled when integral time "1.I" is OFF) The manual reset value equals the output value when PV = SP is true. For example, if the manual reset value is 50%, the output value is 50% when PV = SP becomes true.	50.0%		—
1RP (1.RP)	Zone PID reference point-1	0 to 100% of PV input range. Note that 1.RP ≤ 2.RP.	100% value of PV input range		Ref.5.1(2)

Refer to the table below for recording setpoints when two sets or more of PID parameters are used.

Parameter	n=2	n=3	n=4
n.P			
n.I			
n.D			
n.MR			
n.RP		None	None

rdv (RDV)	Reference deviation	OFF (0), 0.0 to 100.0% of PV input range span Used to select PID constants according to a deviation from the setpoint. The 4th group of PID constants is used when the controller fails to keep track of the deviation.	OFF (0)		—
---------------------	---------------------	---	---------	--	---

■ Setup Parameters

● Control Function-related Parameters

Parameter Symbol	Name of Parameter	Setting Range and Description	Initial Value	User Setting	Target Item in CD-ROM
PCnd (PCMD)	PV color mode	0: Fixed in green 1: Fixed in red 2: Link to PV event 1 (Alarm OFF:green, Alarm ON:red) 3: Link to PV event 1 (Alarm OFF:red, Alarm ON:green) 4: Link to PV event 1 and 2 (Alarm OFF:green, Alarm ON:red) 5: Link to PV event 1 and 2 (Alarm ON:red, Alarm OFF:green) 6: PV limit (Within PV range:green, Out of PV range:red) 7: PV limit (Within PV range:red, Out of PV range:green) 8: SP deviation (Within deviation:green, Out of deviation:red) 9: SP deviation (Within deviation:red, Out of deviation:green)	1		—
HY1 (HY1)	PV event-1 hysteresis	0.0 to 100.0% of PV input range span	0.5% of PV input range span		Ref.3.4(5)
HY2 (HY2)	PV event-2 hysteresis				
CT (CT)	Control output cycle time	1 to 1000 sec.	30 sec.		—
PO (PO)	Preset output	-5.0 to 105.0% In Stop mode, fixed control output can be generated.	0.0%		Ref.2.1(8)
Cnd (C.MD)	PID control mode	0: Standard PID control (with output bump at SP change) 1: Fixed point control (without output bump at SP change) Choose "fixed point control" when controlling pressure or flow rate.	0		Ref.2.1(2)
Ar (AR)	Anti-reset windup (Excess integration prevention)	AUTO (0), 50.0 to 200.0% Used when the control output travels up to 100% or down to 0% and stays at this point. The larger SP, the sooner PID computation (integral computation) stops.	AUTO		Ref.2.1(4)
TMU (TMU)	Program time unit	0: Hour and minute; 1: Minute and second Time unit used when setting a program pattern or a wait time	0		Ref.5.1(1)
SEG.T (SEG.T)	Segment setting method	0: Time setting 1: Ramp setting If the setting of the setup parameter "SEG.T" is changed, the program patterns created and stored so far will be all cleared (initialized) !! Be careful.	0		
P.SL (P.SL)	Protocol selection	0: PC link communication 1: PC link communication (with sum check) 2: Ladder communication 3: Coordinated master station 7: MODBUS (ASCII) 8: MODBUS (RTU)	0		Communication function
bPS (BPS)	Baud rate	0:600, 1:1200, 2:2400, 3:4800, 4:9600 (bps)	4		
Pri (PRI)	Parity	0: None 1: Even 2: Odd	1		
STP (STP)	Stop bit	1, 2	1		
dLn (DLN)	Data length	7, 8; Fixed at 7, when the P.SL parameter is set to MODBUS (ASCII). Fixed at 8, when the P.SL parameter is set to MODBUS (RTU) or Ladder Communication.	8		
Adr (ADR)	Address	1 to 99 However, the maximum number of stations connectable is 31.	1		
rPt (RP.T)	Minimum response time	0 to 10 (× 10 ms)	0		
TEST (TEST)	If this parameter symbol appears, press the SET/ENT key to return to the FUNC menu. Caution: Do not change the setpoint of the TEST parameter, otherwise the indicator will be disabled.				

● Input-/Output-related Parameters

Parameter Symbol	Name of Parameter	Setting Range and Description	Initial Value	User Setting	Target Item in CD-ROM
In (IN)	PV input type (PV INPUT terminals) ① - ⑫ - ⑬ terminals	OFF (0), 1 to 18, 30, 31, 35 to 37, 40, 41, 50, 51, 55, 56 See Instrument Input Range Codes in "2. Initial Settings."	OFF (0)		—
Unit (UNIT)	PV input unit	°C (0): Degree Celsius °F (5): Fahrenheit (This parameter is not shown for voltage input.)	°C (0)		—
rH (RH)	Max. value of PV input range	Set the PV input range, however RL < RH - Temperature input Set the range of temperature that is actually controlled. - Voltage input	Max. value of instrument input range		—
rL (RL)	Min. value of PV input range	Set the range of a voltage signal that is applied. The scale across which the voltage signal is actually controlled should be set using the parameters Maximum Value of PV Input Scale (SH) and Minimum Value of PV Input Scale (SL).	Min. value of instrument input range		—
SDP (SDP)	PV input decimal point position (displayed at voltage input)	0 to 3 Set the position of the decimal point of voltage-mode PV input. 0: No decimal place 1: One decimal place 2, 3: Two, three decimal places	1		—
SH (SH)	Max. value of PV input scale (displayed at voltage input)	-1999 to 9999, however SL < SH Set the read-out scale of voltage-mode PV input.	100.0		—
SL (SL)	Min. value of PV input scale (displayed at voltage input)		0.0		—
rJc (RJC)	Presence/absence of PV input reference junction compensation	OFF (0), ON (1)	ON (1)		—
ErJc (ERJC)	External RJC setpoint	-50.0 to 50.0 °C -58.0 to 122.0 °F	0.0 °C 32.0 °F		
BSL (BSL)	Selection of PV input burnout action	OFF (0) 1: Up scale 2: Down scale	1		—
ot (OT)	Control output type	0 Time proportional PID relay contact output (terminals ①-②-③) 1 Time proportional PID voltage pulse output (terminals ⑩-⑪) 2 Current output (terminals ⑩-⑪) 3 ON/OFF control relay contact output (terminals ①-②-③)	0		—
rEt (RET)	Retransmission output type	1: PV, 2: SP, 3: OUT, 4: Loop power supply for sensor (15 V)	1		
rTH (RTH)	Max. value of retransmission output scale	RET=1, 2: RTL + 1 digit to 100% of PV input range	100% of PV input range		Ref.2.2(1)
rTL (RTL)	Min. value of retransmission output scale	RET=1, 2: 0% of PV input range to RTH - 1 digit	0% of PV input range		
DIS (DIS)	DI function selection	OFF Disables the external contact input. 1 DI1: Starts (on)/stops (off) program-1 operation. DI2: Starts (on)/stops (off) program-2 operation. 2 DI1: Hides (on)/shows (off) the LOCK setup parameter. DI2: Unused. 3 DI1: Starts (on)/stops (off) program-1 operation. DI2: Enables (on)/disables (off) the hold mode of program operation.	OFF (0)		Ref.3.1(5)

Parameter Symbol	Name of Parameter	Setting Range and Description	Initial Value	User Setting	Target Item in CD-ROM
C.S1 (C.S1)	SELECT display-1 registration	OFF (0), 201 to 1015 Select the desired parameter from among the operating and setup parameters, then register the number (D register No.) accompanying that parameter. For example, registering "306" for C.S1 allows you to change proportional band (1.P) in operating display. See User's Manual (Reference) (CD-ROM).	OFF (0)		Ref.6.1(1)
C.S2 (C.S2)	SELECT display-2 registration				
C.S3 (C.S3)	SELECT display-3 registration				
C.S4 (C.S4)	SELECT display-4 registration				
LOCK (LOCK)	Key lock	OFF (0): No key lock 1: Change to any parameter prohibited Prohibits any operating parameter or setup parameter from being changed. The setpoint of the LOCK parameter itself can be changed, however. 2: Change to and display of operating parameters prohibited Turns off the display for setting operating parameters, thus prohibiting any change to the parameter settings. (Hold down the SET/ENT key for more than 3 seconds to show the password check display.) 3: Disables the RESET key on the instrument's front panel. 4: Disables the PRG1 key on the instrument's front panel. 5: Disables the PRG2 key on the instrument's front panel. 6: Disables both the PRG1 and PRG2 keys on the instrument's front panel. 7: Prohibits the parameter settings of program pattern 1 from being changed. 8: Prohibits the parameter settings of program pattern 2 from being changed. 9: Prohibits the parameter settings of both program pattern 1 and program pattern 2 from being changed.	OFF (0)		Ref.7.1(2)
PWD (PWD)	Password setting	0: Password not set 1 to 9999	0		Ref.7.1(1)

■ Auto-tuning

Auto-tuning is a function with which the controller automatically measures the process characteristics to automatically set the optimum PID constants. This function does not work when the controller is performing on-off control. The UP351 employs the “Limit Cycle Method.” As shown in the figure below, the controller temporarily changes its control output in a step-waveform manner. Then, it calculates the optimum proportional band (P), integral time (I) and derivative time (D) from the resulting response to set them in their respective parameters. If the Output High Limit (OH) and Output Low Limit (OL) parameters are already configured, the control output turns on and off only between the output’s high and low limits during auto-tuning.

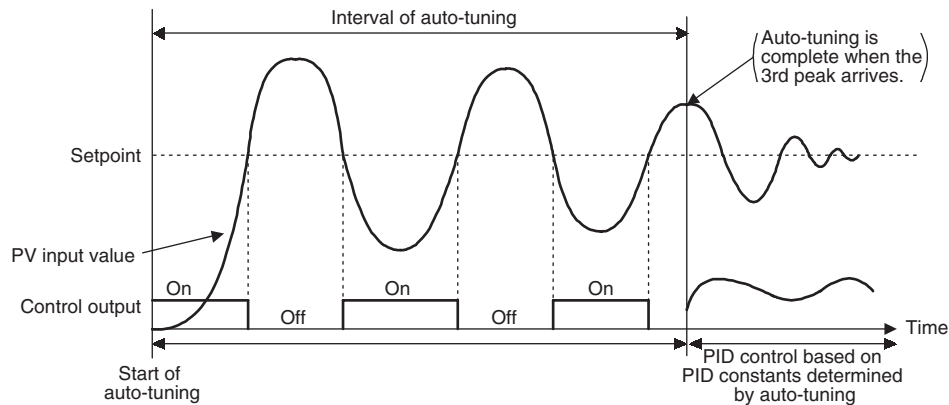

● When One Group of PID Constants is Used (factory-set default)

Setting of AT Parameter	Auto-tuned Setpoint	Remarks
OFF	-	Auto-tuning is turned off (disabled).
1	The setpoints when auto-tuning is started	Determines the values of 1.P, 1.I and 1.D parameters by auto-tuning.

● When Two Groups of PID Constants are Used (See “■ PID Switching (Zone PID)” below)

Setting of AT Parameter	Auto-tuned Setpoint	Remarks
OFF	-	Auto-tuning is turned off (disabled).
1	The setpoints when auto-tuning is started	Determines the values of 1.P, 1.I and 1.D parameters by auto-tuning.
2	The setpoints when auto-tuning is started	Determines the values of 2.P, 2.I and 2.D parameters by auto-tuning.
AUTO	Median value of each zone width	Determines the values of all PID parameters in use by auto-tuning.

● When Three Groups of PID Constants are Used (See “■ PID Switching (Zone PID)” below)

Setting of AT Parameter	Auto-tuned Setpoint	Remarks
OFF	-	Auto-tuning is turned off (disabled).
1	The setpoints when auto-tuning is started	Determines the values of 1.P, 1.I and 1.D parameters by auto-tuning.
2	The setpoints when auto-tuning is started	Determines the values of 2.P, 2.I and 2.D parameters by auto-tuning.
3	The setpoints when auto-tuning is started	Determines the values of 3.P, 3.I and 3.D parameters by auto-tuning.
AUTO	Median value of each zone width	Determines the values of all PID parameters in use by auto-tuning.

● When PID Constants are Selected According to the Deviation (See “■ PID Switching (Zone PID)” below)

Setting of AT Parameter	Auto-tuned Setpoint	Remarks
4	The setpoints when auto-tuning is started	Determines the values of 4.P, 4.I and 4.D parameters by auto-tuning.



NOTE

Set the maximum and minimum values, as close as possible to those of the actual range to be controlled, in the Maximum Value of PV Input Range (RH) and Minimum Value of PV Input Range (RL) parameters. Otherwise, the controller may fail to determine the optimum values when auto-tuning is carried out.

■ PID Switching (Zone PID)

The UP351 carries out control by automatically switching between groups of PID constants according to the temperature zone. You can set a maximum of three temperature zones. When shipped from the factory, the UP351 is configured so that it operates in zone 1 only and using only one group of PID constants.

● When One Group of PID Constants is Used (factory-set default)

As shown in the figure below, the controller uses one group of PID constants over the range from the minimum value to the maximum value of the PV input range.

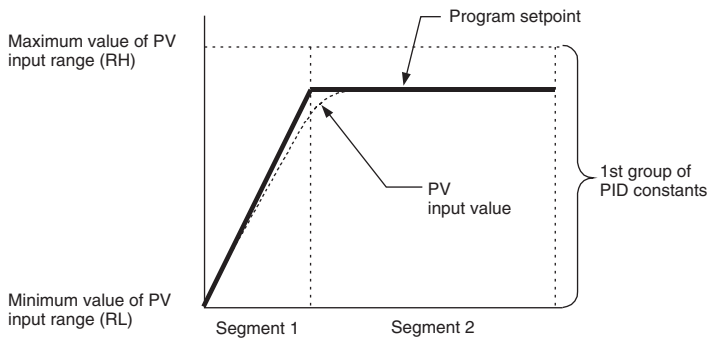

<Controller Settings>

- Configure the 1st group of PID constants (1.P, 1.I and 1.D operating parameters).

● Selection of PID Constants when the Control Range is Split into Three Zones

As shown in the figure below, three zones are set for the controller to automatically switch from one group of PID constants to another. Two zones can also be set for the controller to select between two groups of PID constants.

- [1] The controller uses the 1st group of PID constants if the PV input value is within the zone set off by the minimum value of the PV input range and reference point 1.
- [2] The controller uses the 2nd group of PID constants if the PV input value is within the zone set off by reference point 1 and reference point 2.
- [3] The controller uses the 3rd group of PID constants if the PV input value is within the zone set off by reference point 2 and the maximum value of the PV input range.

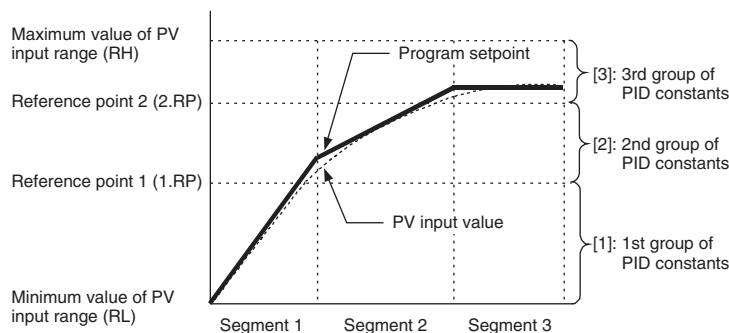

<Controller Settings>

- Splitting the control range into two zones
 - To split the control range into two zones, define reference point 1 (i.e., the 1.RP operating parameter).
 - Define the 1st and 2nd groups of PID constants (i.e., the 1.P, 1.I and 1.D operating parameters for the 1st group and the 2.P, 2.I and 2.D operating parameters for the 2nd group).
- Splitting the control range into three zones
 - To split the control range into three zones, define reference points 1 and 2 (i.e., the 1.RP and 2.RP operating parameters).
 - Define the 1st, 2nd and 3rd groups of PID constants (i.e., the 1.P, 1.I and 1.D operating parameters for the 1st group, the 2.P, 2.I and 2.D operating parameters for the 2nd group and the 3.P, 3.I and 3.D operating parameters for the 3rd group).

● Selecting PID Constants According to the Deviation

PID constants can be selected according to the deviation in two ways. One method is to select a group of PID constants only by a deviation from a program setpoint. The other method is to use a reference point, as discussed earlier, as well as a deviation from a program setpoint, to switch between groups of PID constants. Deviation-based switching has priority over switching based on a reference point.

[Method 1]

As shown in the figure below, the controller selects the 4th group of PID constants if the PV input value goes beyond the given deviation from the program setpoint.

- [1] The controller uses the 1st group of PID constants.
- [2] The controller uses the 4th group of PID constants (i.e., the 4.P, 4.I and 4.D operating parameters for the 4th group).

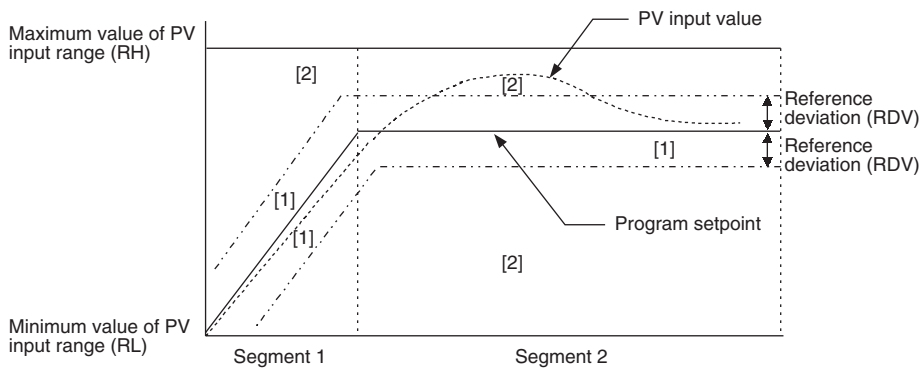

[Method 2]

As shown in the figure below, the controller selects an appropriate group of PID constants for each zone and, if the PV input value goes beyond the given deviation from the program setpoint, selects the 4th group of PID constants.

- [1] The controller uses the 1st group of PID constants if the PV input value is both within the zone set off by the minimum value of the PV input range and reference point 1 and within the given reference deviation bandwidth.
- [2] The controller uses the 2nd group of PID constants if the PV input value is both within the zone set off by reference point 1 and the maximum value of the PV input range and within the given reference deviation bandwidth.
- [3] The controller uses the 4th group of PID constants if the PV input value goes beyond the given reference deviation bandwidth.

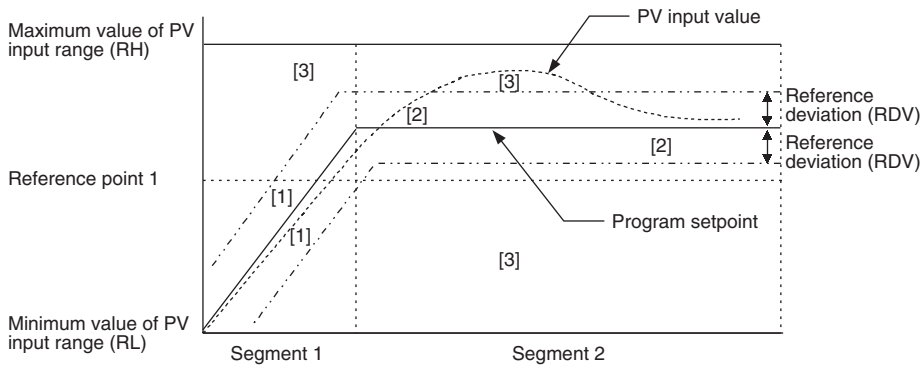

<Controller Settings>

- Splitting the control range into two zones
 - To split the control range into two zones, define reference point 1 (i.e., the 1.RP operating parameter).
 - Define the 1st and 2nd groups of PID constants (i.e., the 1.P, 1.I and 1.D operating parameters for the 1st group and the 2.P, 2.I and 2.D operating parameters for the 2nd group).
 - Define the reference deviation (i.e., the RDV operating parameter).

TIP

The RDV parameter appears after the 4th group of PID parameters.

- Splitting the control range into three zones
 - To split the control range into three zones, define reference points 1 and 2 (i.e., the 1.RP and 2.RP operating parameters).
 - Define the 1st, 2nd and 3rd groups of PID constants (i.e., the 1.P, 1.I and 1.D operating parameters for the 1st group, the 2.P, 2.I and 2.D operating parameters for the 2nd group and the 3.P, 3.I and 3.D operating parameters for the 3rd group).
 - Define the reference deviation (i.e., the RDV operating parameter).

TIP

The RDV parameter appears after the 4th group of PID parameters.

● Hysteresis for PID switching (if Zone PID is used)

Hysteresis is set for PID switching at reference point 1, as shown in the figure below. The hysteresis bandwidth is fixed at 0.5% of the span of the PV input range. Reference point 2 behaves in the same way as reference point 1, though the figure shows reference point 1 only.

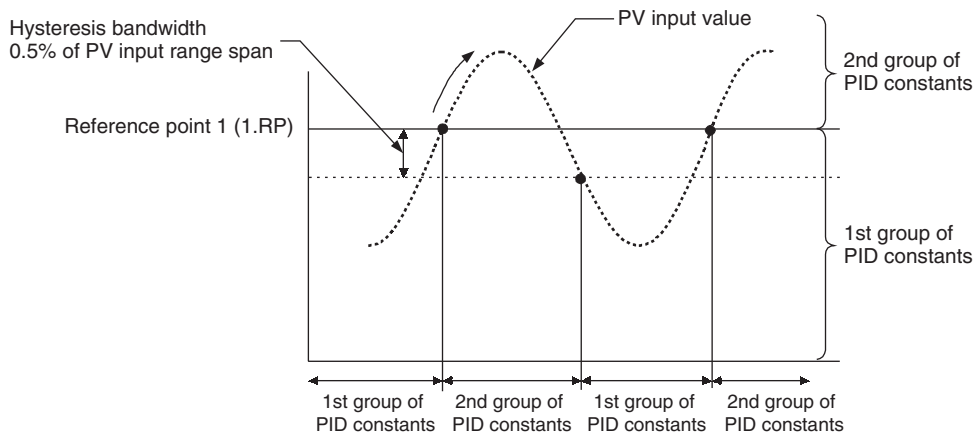

■ Hysteresis (Setpoints for On-Off Control and PV Event Setpoints)

Hysteresis can be set in on-off control setpoints and PV event setpoints as well. With the hysteresis settings, it is possible to prevent relays from chattering.

- When hysteresis is set in an on-off control setpoint

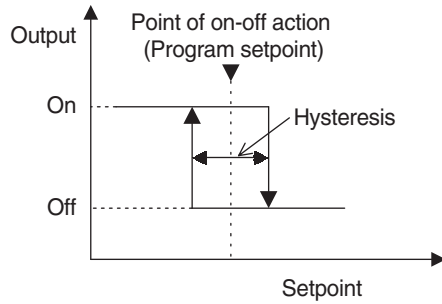

Hysteresis (H): Operating parameter

- When hysteresis is set in a PV event setpoint

Example of hysteresis set in PV input high limit alarm

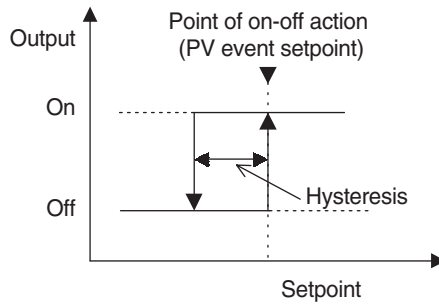

PV event-1 hysteresis (HY1): Setup parameter
PV event-2 hysteresis (HY2): Setup parameter

■ Functions of Active Color PV Display

This part describes the functions of “Active Color PV Display.” PV display color is changed by the following four actions.

PV display is selectable from red-to-green or green-to-red changing action, or fixed color.

Link to PV event 1 mode (when PCMD = 2, 3) (Setting example-1)

Link to PV event 1 and 2 mode (when PCMD = 4, 5) is the same. When either of the alarms occurs, the display color is changed.

SP deviation mode (when PCMD = 8, 9) (Setting example-2)

PV limit mode (when PCMD = 6, 7) (Setting example-3)

Fixed color mode (when PCMD = 0, 1) (Setting example-4)

Setting Example-1 : Link to PV event

Works linked to PV event 1.
Set “PV high limit alarm” for alarm 1 type, and “80°C” for PV event 1 setpoint.
If PCMD (PV color mode parameter) = 2, PV display color is changed from green to red when PV input value exceeds PV event 1 setpoint.
The red-to-green changing action is selectable.

Setting parameters
PCMD (PV color mode parameter) = 2
n.AL1 (PV event 1 type parameter) = 1
n.A1 (PV event 1 setpoint parameter) = 80°C
HY1 (PV event 1 hysteresis parameter) = 5°C

n=1,2

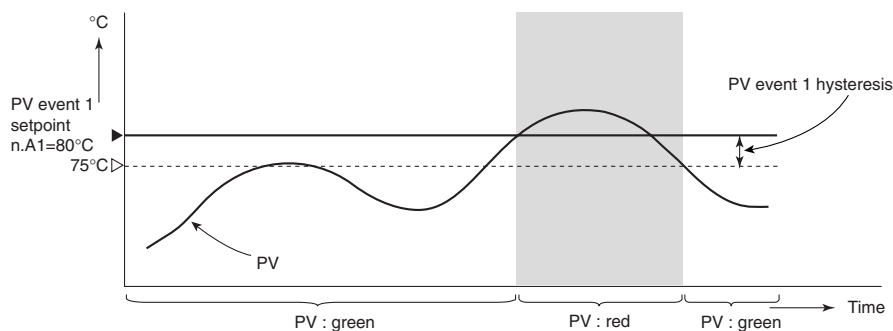

Setting Example-2 : Change by Deviation

Set high limit deviation band “10°C” for PCCH, and low limit deviation band “5°C” for PCCL against current setpoint “50°C.”

PV display color is changed from green to red when PV input value is out of the deviation.

The red-to-green changing action is selectable.

Setting parameters
PCMD (PV color mode parameter) = 8
PCCH (High limit for PV color change parameter) = 10°C
PCCL (Low limit for PV color change parameter) = 5°C
Hysteresis fixed to 0.25% is inserted where PV display color is changed.
In the example blow, where changed from red to green.

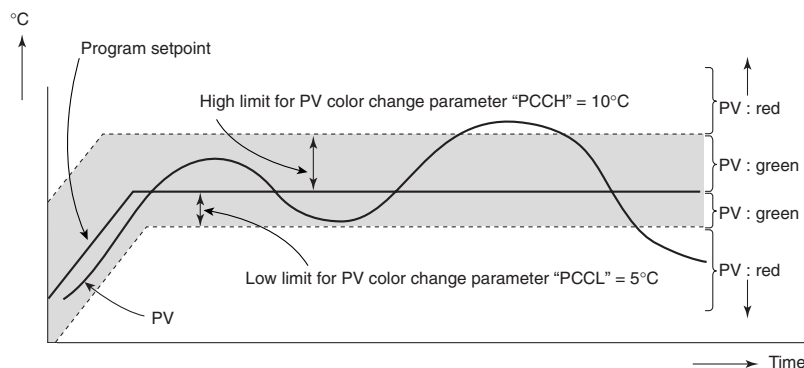

Setting Example-3 : Link to PV

Set high limit "70°C" for PCCH, and low limit "20°C" for PCCL.
PV display color is changed from green to red when PV input value is out of the range.
The red-to-green changing action is selectable.
Setting parameters
PCMD (PV color mode parameter) = 6
PCCH (High limit for PV color change parameter) = 70°C
PCCL (Low limit for PV color change parameter) = 20°C
Hysteresis fixed to 0.25% is inserted where PV display color is changed.
In the example blow, where changed from red to green.

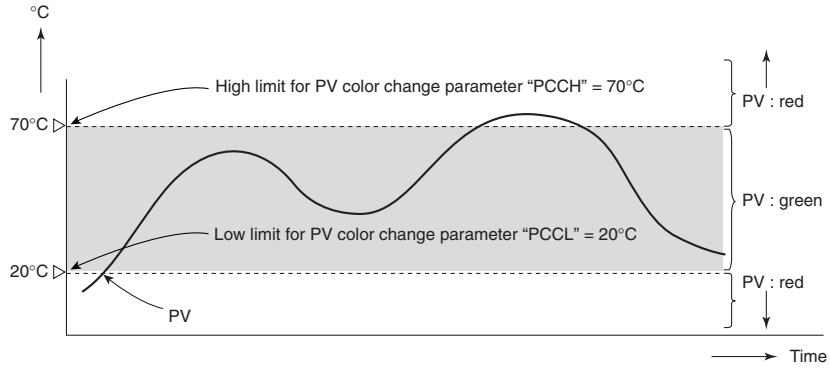

Setting Example-4 : Fixed in Red or Green

Set the PV display color or Fixed in green mode, Setting of Fixed to red mode is also possible.
Setting parameter
PCMD (PV color mode parameter) = 0

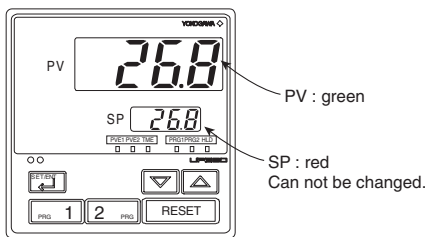

External RJC

External RJC is not a compensation function built in a controller but a compensation function working outside the controller.

External RJC is used when input is thermocouple, and RJC=OFF.

Using External RJC makes the accuracy of RJC higher and shortens the compensating wire.

Parameter Symbol	Name of Parameter	Setting Range	Initial Value
ErJC (ERJC)	External RJC setpoint	-50.0 to 50.0°C, -58.0 to 122.0°F For thermocouple input, temperature compensation value outside the controller can be set. Available only when RJC=OFF.	0.0°C 32.0°F

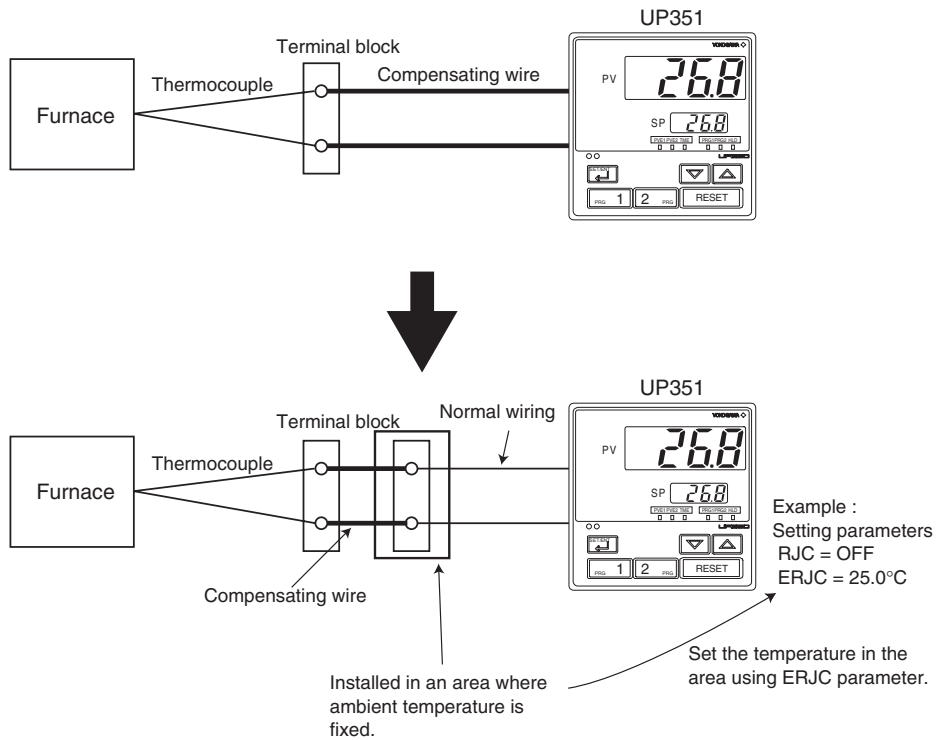

■ Useful Operating Display (SELECT Display)

Registering frequently changed parameters in the SELECT display after ordinary operating displays will allow you to change settings easily. A maximum of four displays can be registered.

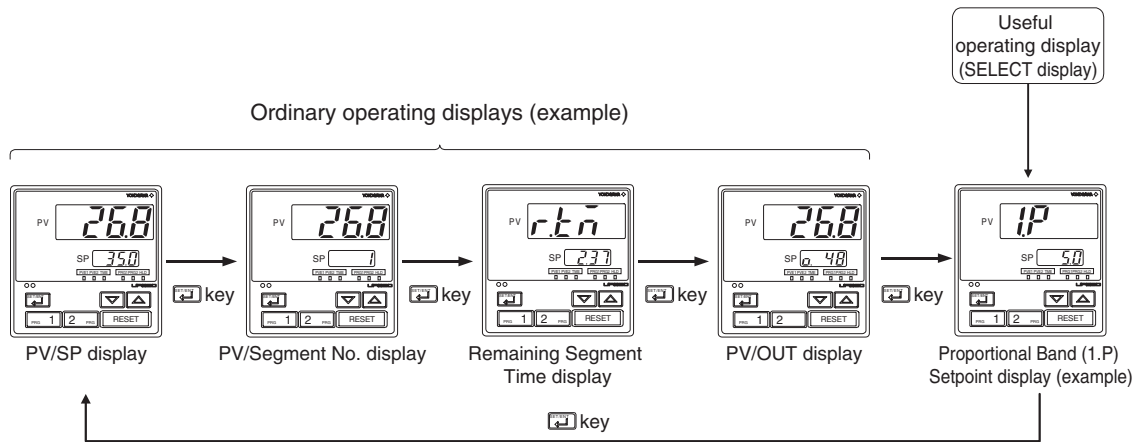

<Setting Method>

Set the numbers of parameters (D registers) in the setup parameters from C.S1 to C.S4 you want to register with SELECT displays.

1st group of PID Parameters	Registration No.	2nd group of PID Parameters	Registration No.	3rd group of PID Parameters	Registration No.	4th group of PID Parameters	Registration No.
Proportional band (1.P)	306	Proportional band (2.P)	331	Proportional band (3.P)	356	Proportional band (4.P)	381
Integral time (1.I)	307	Integral time (2.I)	332	Integral time (3.I)	357	Integral time (4.I)	382
Derivative time (1.D)	308	Derivative time (2.D)	333	Derivative time (3.D)	358	Derivative time (4.D)	383

For any registration number other than those above, see User's Manual (Reference) (CD-ROM version).

■ Cycle Time

A cycle time can only be set if the type of control output is time proportional PID relay output or time proportional voltage pulse output.

A cycle time refers to one period consisting of on- and off-state time lengths. The ratio of the on-state time to the off-state time differs according to the value of the control output. The figure below shows on-to-off time ratios of the control output when the cycle time is set to 10 seconds. Setting a shorter cycle time allows the controller to perform elaborate control at short time intervals. This significantly reduces the on- and off-state times, however it shortens the service life of a relay.

Cycle time (CT): Setup parameter

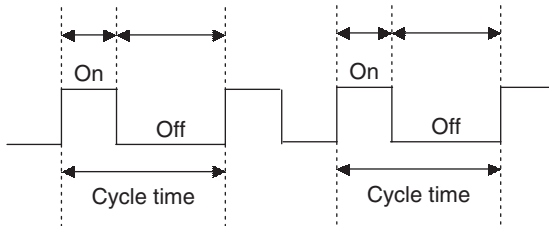

Relay's Behavior when Cycle Time = 10 sec.

For 20% of Control Output	For 50% of Control Output	For 80% of Control Output

■ Limiting the Control Output (Output Limiter)

As shown in the figure below, you can set the high and low limits within the range of control output to restrict the control output. This feature is disabled, however, when the controller is at a stop (RESET state).

Output high limit (OH) : Operating parameter

Output low limit (OL) : Operating parameter

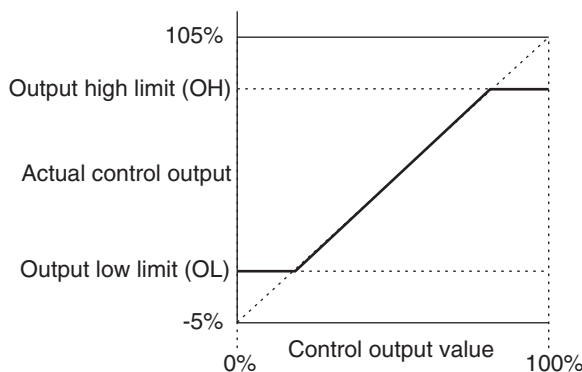

Blank Page

7. Function Block Diagram and Descriptions

This chapter contains the function block diagram for “Standard type.” For details on this function block diagram, refer to the descriptions mentioned later.

■ Function Block Diagram for Standard Type

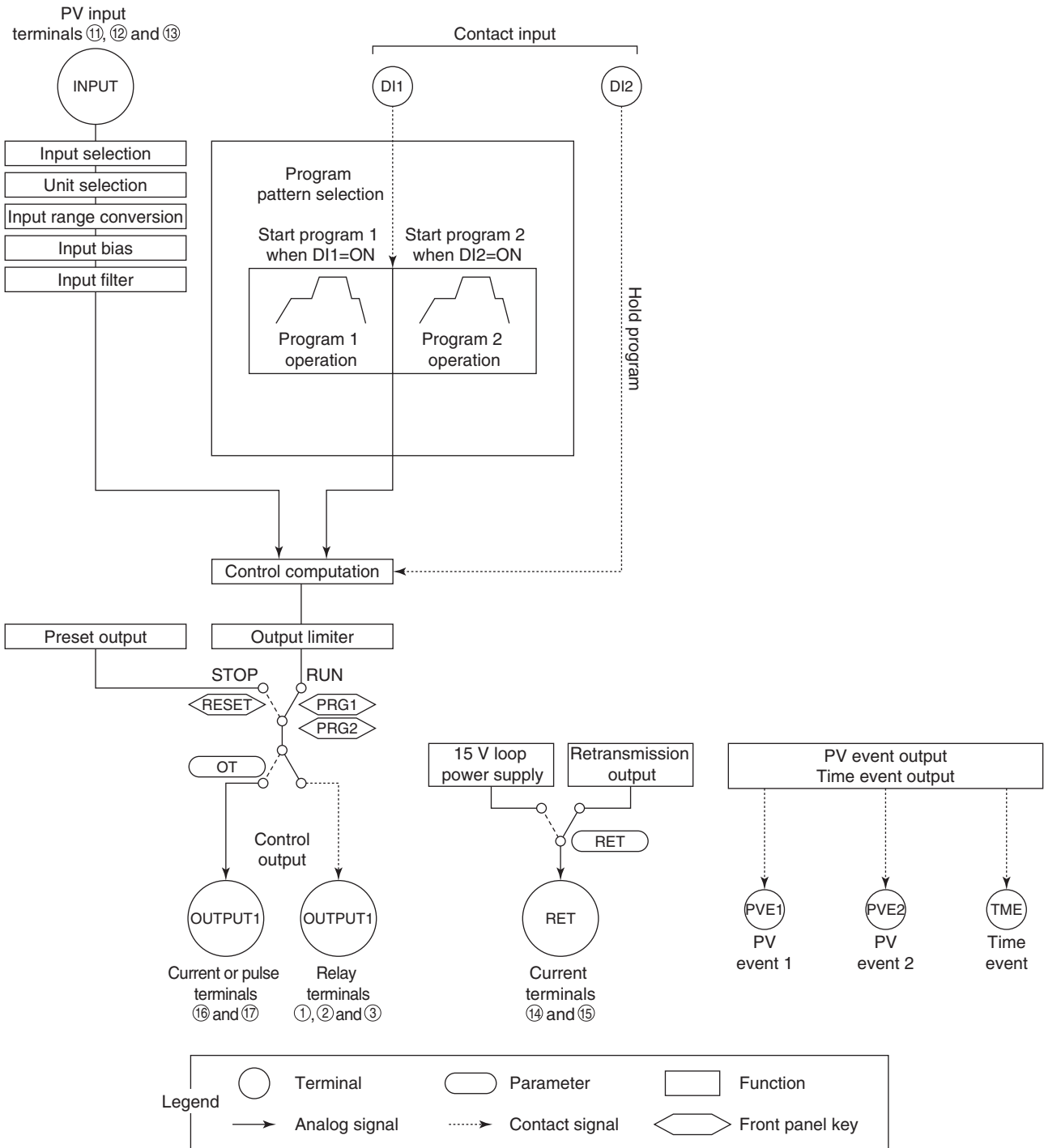

* DIS is a setup parameter.
Changing DIS setpoint allows you to change the function of external contact input.

Correspondence between parameter DIS and external contact input functions			
When DIS=OFF (Factory-set default)	When DIS=1	When DIS=2	When DIS=3
No function	Start program 1 when DI1 = ON Reset program 1 when DI1 = OFF	Hide setup parameter lock when DI1 = ON Show setup parameter lock when DI1 = OFF	Start program 1 when DI1 = ON Reset program 1 when DI1 = OFF
No function	Start program 2 when DI2 = ON Reset program 2 when DI2 = OFF	No function	Hold program when DI2 = ON Cancel hold when DI2 = OFF

Functions and Parameters for “Standard Type” in Initial State (Factory-set default)

Functions and parameters in initial state are given in the tables below. For details on each parameter, refer to, “6.2 Lists of Parameters.”

■ PV Input

PV input (INPUT) is a universal input, which can receive signals from thermocouple, RTD, or DC voltage signals. The controller is capable of biasing, and first-order lag computation (filtering) on input signals.

Each function can be set by the following parameters.

Setup Parameters

Function	Parameter	Menu
Input selection	IN	I/O
Unit selection	UNIT	I/O
Input range conversion	RH, RL	I/O

Operating Parameters

Function	Parameter	Menu
PV input bias	BS	OP.PA
PV input filter	FL	OP.PA

■ Contact Input

Changing the setpoint of the parameter DIS (DI function selection) allows you to change the function of contact input.

● When DIS=OFF

No function for contact input.

● When DIS=1 (factory-set default)

Start program 1 (ON)/Reset program 1 (OFF) switching function is assigned to DI1 (contact input 1).

Start program 2 (ON)/Reset program 2 (OFF) switching function is assigned to DI2 (contact input 2).

Preset output value is output when the operation is stopped. PV input remain functioning as normal.

● When DIS=2

Hide (ON)/Show (OFF) the parameter LOCK (key lock) switching function is assigned to DI1 (contact input 1).

No function is assigned to DI2 (contact input 2).

● When DIS=3

Start program 1 (ON)/Reset program 1 (OFF) switching function is assigned to DI1 (contact input 1).

Hold program (ON)/Cancel hold (OFF) switching function is assigned to DI2 (contact input 2).

Preset output value is output when the operation is stopped. PV input remain functioning as normal.

■ Control Output

Control output (OUTPUT) selects the output type among the current output, voltage pulse output, and relay contact output signal.

Preset output value is output when the operation is stopped by key operation or contact input.

Each function can be set by the following parameters.

Setup Parameters

Function	Parameter	Menu
Control output type selection	OT	I/O
Control output cycle time	CT	FUNC
Preset output	PO	FUNC

Operating Parameters

Function	Parameter	Menu
Output limiter	OL, OH	OP.PA

■ Contact Output

PV event 1 is output via PVE1.

PV event 2 is output via PVE2.

Time event is output via TME.

Program Parameters

Function	Program 1 Parameter	Program 2 Parameter
PV event-1 type	1.AL1	2.AL1
PV event-1 setpoint	1.A1	2.A1
PV event-2 type	1.AL2	2.AL2
PV event-2 setpoint	1.A2	2.A2
On time of time event	1.EOF	2.EOF
Off time of time event	1.EON	2.EON

■ Retransmission Output

PV, target setpoint, or control output can be output to retransmission output (RET).

Each function can be set by the following parameters.

Setup Parameters

Function	Parameter	Menu
Retransmission output type	RET	I/O
Retransmission output scale	RTH, RTL	I/O

■ 15 V DC Loop Power Supply

The 15 V DC loop power supply (RET) uses the same terminal as retransmission output. The 15 V DC loop power supply can not be used when retransmission output is used. To use the 15 V DC loop power supply, set "4" in retransmission output type selection parameter RET.

Each function can be set by the following parameters.

Setup Parameters

Function	Parameter	Menu
Retransmission output type	RET	I/O

Blank Page

Revision Information

- Title : Model UP351 Program Controller User's Manual
- Manual No. : IM 05E01D12-41E

May 2003/1st Edition

Newly published

Sep 2003/2nd Edition

Complies with safety and EMC standards.

Jul 2004/3rd Edition

Change of the company name

May 2006/4th Edition

Revision by the change of safety standard description

Written by Yokogawa Electric Corporation

Published by Yokogawa Electric Corporation
2-9-32 Nakacho, Musashino-shi, Tokyo 180-8750, JAPAN

Blank Page

YOKOGAWA

Yokogawa Electric Corporation

YOKOGAWA ELECTRIC CORPORATION

Network Solutions Business Division

2-9-32, Nakacho, Musashino-shi, Tokyo, 180-8750 JAPAN

Phone: +81-422-52-7179 Facsimile: +81-422-52-6793

Sales Branch Offices

Tokyo, Nagoya, Osaka, Hiroshima, Fukuoka

YOKOGAWA CORPORATION OF AMERICA

Headquarters

2 Dart Road, Newnan, GA. 30265-1094 U.S.A.

Phone: +1-770-253-7000 Facsimile: +1-770-251-0928

Sales Branch Offices / Texas, Chicago, Detroit, San Jose

YOKOGAWA EUROPE B. V.

Headquarters

Databankweg 20, 3821 AL Amersfoort THE NETHERLANDS

Phone: +31-334-64-1611 Facsimile: +31-334-64-1610

Sales Branch Offices / Houten (The Netherlands), Wien (Austria), Zaventem (Belgium), Ratingen (Germany), Madrid (Spain), Bratislava (Slovakia), Runcorn (United Kingdom), Milano (Italy), Vélizy villacoublay(France), Johannesburg(Republic of South Africa)

YOKOGAWA AMERICA DO SUL S.A.

Headquarters & Plant

Praca Acapulco, 31-Santo Amaro, Sao Paulo/SP, BRAZIL CEP-04675-190

Phone: +55-11-5681-2400 Facsimile: +55-11-5681-4434

YOKOGAWA ENGINEERING ASIA PTE. LTD.

Head office

5 Bedok South Road, Singapore 469270 SINGAPORE

Phone: +65-6241-9933 Facsimile: +65-6241-2606

YOKOGAWA ELECTRIC KOREA CO., LTD.

Seoul Sales office

395-70, Shindaebang-dong, Dongjak-gu, Seoul,156-010, KOREA

Phone: +82-2-3284-3000 Facsimile: +82-2-3284-3019

YOKOGAWA TAIWAN CORPORATION

Head office

17F, No.39, Sec. 1, Chung Hwa Road Taipei, 100 TAIWAN

Phone: +886-2-2314-9166 Facsimile: +886-2-2314-9918

YOKOGAWA AUSTRALIA PTY. LTD.

Head office

CentreCourt D1, 25-27 Paul Street North, North Ryde, N. S. W. 2113, AUSTRALIA

Phone: +61-2-9805-0699 Facsimile: +61-2-9888-1844

YOKOGAWA INDIA LTD.

Head office

40/4 Lavelle Road, Bangalore, 560 001, INDIA

Phone: +91-80-227-1513 Facsimile: +91-80-227-4270

LTD. YOKOGAWA ELECTRIC

Grokholskiy per. 13, Build. 2, 4th Floor, 129010, Moscow, RUSSIA FEDERATION

Phone: +7-095-737-7868 Facsimile: +7-095-737-7869
