



**AUTOMATIC
TIMING & CONTROLS**



7DT-2CH 7-Day Timer INSTALLATION & OPERATION MANUAL

8019 Ohio River Boulevard
Newell, WV 26050
304.387.1200

www.automatictiming.com
800.727.5646

<u>Table of Contents</u>	<u>Page</u>
I. Specification.....	2
II. Warning.....	2
III. Features of the Device.....	3
IV. Controls/Menu Description.....	3
1. Menu Flow Chart.....	3
2. Description of the Device.....	4
3. Description of the Control Buttons and Mode.....	4
4. Economical Mode.....	5
5. Illumination of Display.....	5
6. Reset the Time, Date, and Year.....	5
7. Reset all the Programs.....	5
V. Setting the Date and Time.....	6
VI. Programming.....	7
1. Mode Priorities.....	7
2. Normal Mode.....	7
3. Repeat Cycle Mode.....	9
4. Pulse Mode.....	10
5. Random Switching Mode.....	11
6. Manual Mode.....	12
7. Cycle/Pulse Output Setting.....	12
8. Editing Programs.....	13
9. Deleting Programs.....	13
10. Setting the Holiday Mode.....	14

I.) Specification:

Model	7DT-2CH
Power Supply	Universal 12-240 VAC or VDC (50-60 Hz)
Power Consumption	AC 0.5-2 VA / DC 0.4-2W
Allowable Operation Voltage	-15%; +10%
Number of Outputs	2 Independent Form C Relay Outputs
Contact Rating	2 Independent SPDT (Single Pole Double Throw Contact) 16 amps @ 250 VAC & 24 VDC Resistive Load
Switching Capacity	4000 VA/AC, 384 W/DC
Peak Current	30 amps / <3 sec.
Mechanical Durability	>30,000,000 operations
Electric Durability	>70,000 operations
Operational Backup during Power Failure	Up to 3 years
Accuracy of the Operating	Max. +/- 1 Second Day at 20°
Minimum Run Time	1 minute (Normal Mode); 1 second (Pulse Mode); 2 second (Cycle Mode)
Number of Memory Places	100
Display	LCD
Operational Temperature	-10° to 55° C
Storing Temperature	-30° to 70° C
Dimension	90 x 35.6 x 64 mm
Weight	137 grams

II.) Warning:

The device is made to be connected to Single-Phase AC and DC voltage and must be installed in accordance with rules and standards applicable in the particular country. The installation, connecting, setting and handing can be done only by a person with the adequate electromechanical qualification, who is well informed about the function of this device and the manual.

Before you start with installation, make sure that the device is not energized and that the main switch is in the "OFF" position.

Do not install the device to the sources of excessive electromagnetic disturbances. Assure an excellent circulation of the air by correct installation so the maximal operating temperature of the device is not surpassed even in case of permanent operation and higher temperature of the surrounding. To install and set, use a screwdriver with 2 mm dimension. Be aware of the fact that it is a fully electronic device while handing it.

Proper function of the device depends on the transport, storing and handling. If you find any marks of damage, missing part, or if the device seems not operational, do not install this device and claim the warranty at your distributor. After completion of the useful life of the device it must be stored in protective waste dump.

III.) Features of the Device:

- Two-channel version, mounting on DIN rail, terminals
- Daily and weekly program in one device
- Power supply 12-240 VAC / VDC
- Functions: according to the user program, manual, random, and holiday program modes.
- 100 memory places, illuminated LCD display
- Operational back up – up to 3 years
- Pulse and repeat cycle output

**Before you start programming this timer switch, please make sure to read carefully through the following instructions.*

IV.) Controls/Menu Description:

1.) Menu flow chart

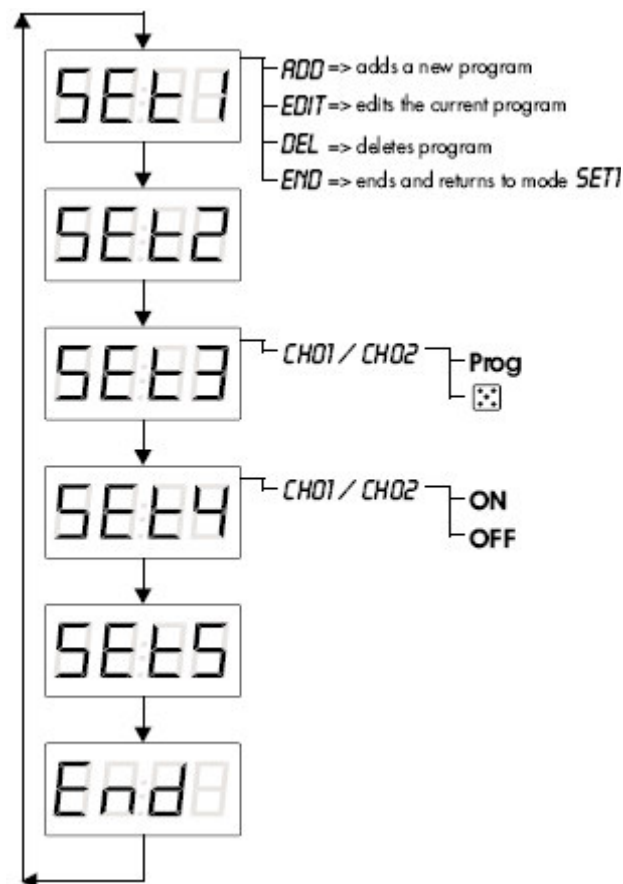

2.) Description of the Device

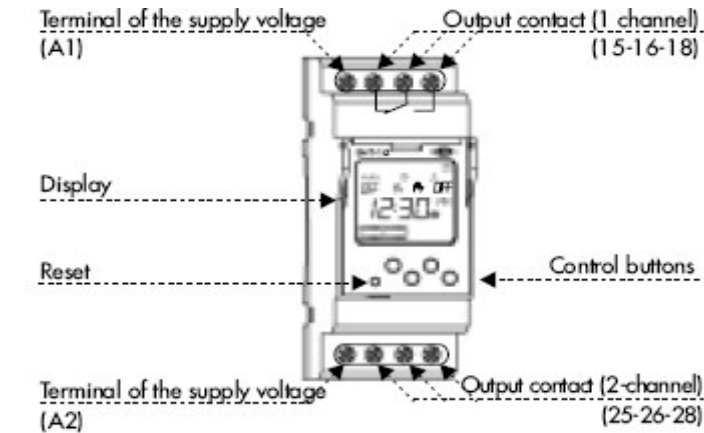

DISPLAY DESCRIPTION

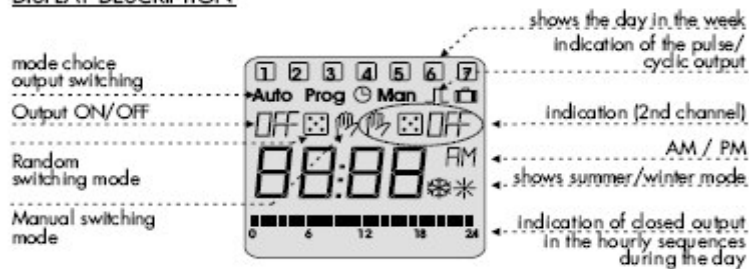

3.) Description of the Control Buttons and Modes

button	ORIGINAL MODE		PROGRAMING MODE	
	SHORTLY ○	LONG ●	SHORTLY ○	LONG ●
+PRG	/	entrance to the program	upwards	fast upwards
-MAN1	Manual mode 1 channel	/	downwards	fast downwards
MAN2 ESC	Manual mode 2 channel	/	one level up	entrance to the start mode
OK	searching date/year	/	confirm	/

- There are four control buttons located on the face of the unit just below the display
- First button going from left to right is the (PRG) button) this button is used to enter the program setup menus by pressing and holding it down for 3 seconds
- The PRG button has a plus sign (+) located right below the PRG on the face
- The next button on the right of the (+PRG) button is the (-MAN) button
- The (MAN) button can be quickly pressed while in the run mode operation to quickly turn on output 1 on and off manually

- f) There is also a minus sign (-) located underneath this button which means that when the unit is in the program mode, this button can be quickly pressed to go back to the previous screen or menu
- g) The third button from the left is the (MAN2) which works just like the MAN button except it controls the output 2 relay during run mode
- h) The third button from the left also works as a double button (ESC), which is used during the program mode to exit out of the menu or out of the program mode and back to the run mode
- i) The button on the far right is the (OK) button
- j) The (OK) button can be used to scroll through the date, time, and year setting during run mode operation by quickly pressing the button
- k) The (Ok) button is also used as the enter button from entering the program parameters in the program mode

4.) Economical Mode

The 7DT-2CH is shipped with a pre-programmed real time in economical mode. The unit uses battery memory which allows the unit to keep data stored even when the unit does not have supply voltage on terminals A1 and A2. This device is capable of viewing the time with no supply voltage present by pressing any of the control buttons for two seconds. The 7DT-2CH display will illuminate and display pre-set time. When supply voltage is connected to terminals A1 and A2 the unit will continuously display the timing switch's status until supply voltage is removed.

5.) Illumination of Display

The 7DT-2CH illuminates whenever one of the control buttons are pressed and remains that way for 10 seconds after the last button was pressed. To have the LCD display stay illuminated permanently. The three control buttons (ESC/MAN2), (-MAN1), and the (OK) must be pressed and held down together for 3 seconds. The display will flicker once to show that the permanent illuminated feature has been entered. The same three buttons again must be pressed and held down simultaneously to turn the display illumination feature off. The display will flicker and then turn the display light off.



6.) Reset the Time, Date, and Year

The 7DT-2CH has a small hidden reset button located on the front left side of the unit (this can be seen on page 4 under *description of the device*). By using a pin with a diameter no bigger than 2 mm you can press this small hidden reset button (when pressed the screen will go blank). Upon releasing the button the display will show SHT-1 for 3 seconds (This is the version of firmware used) and go to starting mode. The reset will delete the real time, the set time of the pulse/cycle mode and all temporary functions. Reset will keep the set programs.

7.) Reset all the Programs

All stored programs can easily be erased by pressing down and holding both (+PRG) and (OK) buttons simultaneously for a few seconds. The word ALL will be displayed once the two control buttons have been held down. Now just push the (OK) button and the unit will delete all existing programs

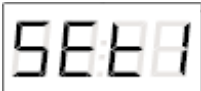
V.) Setting the Date and Time

- a) Press and hold the (+PRG) button for 3 seconds,  is what will display on the LCD screen (also you will see **prog** in the upper left corner of the display)
- b) Now press the (+PRG) button to move to the next program option,  is now shown on the LCD screen (also you will see a ⌚ symbol in the upper middle part of the display screen)

- c) Press the (OK) button to enter the year setting menu  (once in the display should have the last two digits blinking)
- d) By using the (+PRG) and the (-MAN) buttons you can change the year
- e) Once you have the number on the correct year press the (OK) button to save it to the memory and move to the next set up option
- f) 7DT-2CH display should have the first two digits blinking waiting on a new

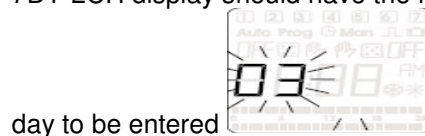

day to be entered

- g) Again use the (+PRG) and the (-MAN) buttons to change the two digits to the correct day of the month
- h) Press (OK) button to enter the day into the memory of the 7DT-2CH
- i) The day is still displayed on the first two digits and now the second two digits are blinking
- j) Once again by using the (+PRG) and the (-MAN) buttons you can scroll up and down to change the numeric values to represent the month of the year (1-12)
- k) Press (OK) button
- l) Now 24 is blinking (the unit will be in military time in this setting: example 13:30 is 1:30 P.M.)
- m) Use the (+PRG) or (-MAN) buttons to choose between the 24 hours setting or the 12 hour setting (In 12 hours setting unit uses a.m. and p.m.)
- n) Press the (OK) button on either the 24 or 12
- o) Now use the (+PRG) and (-MAN) buttons to set the hours digits of the timer
- p) Press the (OK) button
- q) Now use the (+PRG) and (-MAN) buttons to set the minutes digits of the timer
- r) Press the (OK) button to enter the data into memory
- s) Now the unit will display On or OFF with two symbols representing summer



and winter to the right

- t) Use the (+PRG) or (-MAN) buttons to scroll between the two chooses (On or OFF)

- u) If you choose OFF and press (OK) button, the display will return back to the



- v) If you choose On and press (OK) button, you need to select the snow flake or sun star by scrolling with (+PRG) or (-MAN) buttons and then pressing the (OK) button (automatic switching is activated)
- w) After correct symbol of the seasonal time has been chosen then press the

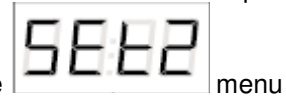

- (OK) button and the display will return to the
- x) Press the (ESC/MAN2) button to exit out of the program mode and back to the original run mode

VI.) Programming

1.) Mode Priorities

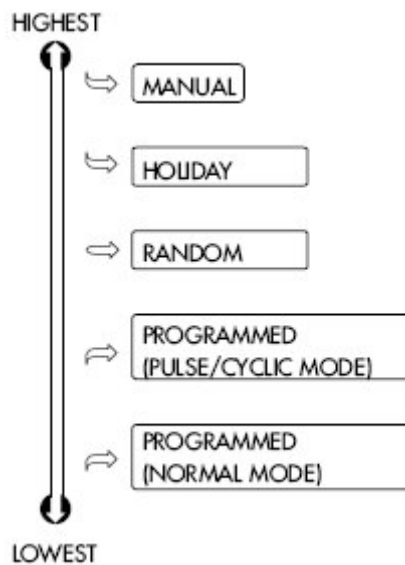

2.) Normal Mode

In the normal mode, output is switched according to the set start and stop time. You must first program a start time and which days of the week that the output is to turn on. Next you need to program the end time for the 7DT-2CH unit to turn off the output at a giving time for each set day.

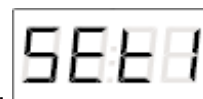

- a) Press and hold the (+PRG) button for 3 seconds, is what shows on the LCD display (also you will see **prog** in the upper left corner of the display)

- b) Press the (OK) button to enter into the programming parameters (the word **ADD** will be shown now)
- c) Press the (OK) button (information about the number of the new program



Pr.XX) example: this just gives a numeric values to the memory location of this program

- d) Now press the (OK) button (**Ch01** or **Ch02** should display)
- e) You can choose weather to control output 1 or output 2 by scrolling between them with the (+PRG) or (-MAN) buttons



- f) Press (OK) button, should be displayed on the LCD screen [Note - If the screen doesn't look like this than scroll with (+PRG) or (-MAN) buttons until it does]
- g) Press (OK) button
- h) The two hours digits on the left side of the display should be blinking, adjust the numbers using the (+PRG) or (-MAN) buttons to set the desired hour that you want the output to come on and than press the (OK) button
- i) Now the two minutes digits are blinking on the right side of the display, adjust the numbers using the (+PRG) or (-MAN) buttons to the desired minute time that you want the output to come on and than press the (OK) button
- j) Now it is time to select which days of the week this program will be on for by pressing the (OK) button on either on or off along with the corresponding number in the top of the display that represents the days of the week,

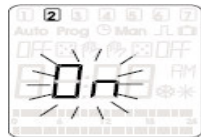

- k) Choose **ON** or **OFF** by using (+PRG) or (-MAN) to scroll between the two chooses and (OK) to enter the choose (the numbers at the top represent the days of the week by the number **1 = Monday** and the **7 = Sunday**)
- l) Once the last day has been entered the word **ADD** is displayed and the two indicator bars will increase from left to right on the display and once the program has been saved the unit will say **ADD** with no indicator bars illuminated at the bottom of the screen
- m) Press (OK) button, (will go back to the PR.XX screen the difference this time is that the numeric values has increase by one: example **PR.01** when you entered the first program but now the display will read **PR.02**)
- n) Press (OK) button again, (now the display reads either **CH01** or **CH02** depending on which output you entered in the last program)
- o) Choose the same output channel as before so than you can enter a stop time for the output
- p) Press (OK) button, (**Out** should be displayed on the screen just like in step f except the word **OFF** should shows up in the upper left corner, [Note - If the screen doesn't look like this than scroll with (+PRG) or (-MAN) buttons until it does]
- q) Press (OK) button
- r) Now repeat steps H through L to enter the time of day and which days of the week you want to turn the corresponding output off [Note: make sure to choose the same days of the week to be **ON** in step J has you did in the previous program set up]

- s) Once programming is completed and the word **ADD** is again displayed and you are finished adding programs then hit the (MAN 2/ESC) button twice to exit back to original run mode (the indicator bar that goes with the corresponding output should be illuminated at the button only on times where the output is going to be on for that day)

3.) Repeat Cycle Mode

The repeat cycle mode works the same way as the “normal mode” except the output cycles on and off between set times. The output will turn on and off for whatever the predetermined time was set in the, “*Cycle/Pulse Setting*”, section on page 12. Both the on and off time have a range of 1 to 99 seconds each.

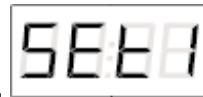

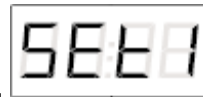
- a) Press and hold the (+PRG) button for 3 seconds,  is what shows on the LCD display (also you will see **prog** in the upper left corner of the display)
- b) Press the (OK) button to enter into the programming parameters (the word **ADD** will be shown now)
- c) Press the (OK) button, (information about the number of the new program



Pr.XX) example:  this just gives a numeric values to the memory location of this program

- d) Now press the (OK) button, (**Ch01** or **Ch02** should display)
- e) You can choose weather to control output 1 or output 2 by scrolling between them with the (+PRG) or (-MAN) buttons



- f) Press (OK) button,  should be displayed on the LCD screen
- g) Use the (+PRG) or (-MAN) buttons to scroll through menu options so that the display looks like it does in step F, EXCEPT the JL sign is illuminated in the upper right of the display screen as well (this is how the repeat cycle mode is activated)
- h) Press the (OK) button
- i) The two hours digits on the left side of the display should be blinking, adjust the numbers using the (+PRG) or (-MAN) buttons to set the desired hour that you want the output to come on and than press the (OK) button
- j) Now the two minutes digits are blinking on the right side of the display, adjust the numbers using the (+PRG) or (-MAN) buttons to the desired minute time that you want the output to come on and than press the (OK) button
- k) Now it is time to select which days of the week this program will be on for by pressing the (OK) button on either on or off along with the corresponding number in the top of the display that represents the days of the week,



- l) Choose **ON** or **OFF** by using (+PRG) or (-MAN) to scroll between the two chooses and (OK) to enter the choose (the numbers at the top represent the days of the week by the number **1 = Monday** and the **7 = Sunday**)
- m) Once the last day has been entered the word **ADD** is displayed and the two indicator bars will increase from left to right on the display and once the program has been saved the unit will say **ADD** with no indicator bars illuminated at the bottom of the screen
- n) Press (OK) button, (will go back to the PR.XX screen the difference this time is that the numeric values has increase by one: example **PR.01** when you entered the first program but now the display will read **PR.02**)
- o) Press (OK) button again, (now the display reads either **CH01** or **CH02** depending on which output you entered in the last program)
- p) Choose the same output as before so then you can enter a stop time for the output
- q) Press (OK) button, (**Out** should be displayed on the screen just like in step f except the word **OFF** should show up in the upper left corner, [Note - If the screen doesn't look like this than scroll with (+PRG) or (-MAN) buttons until it does and also \perp sign will not be illuminated]
- r) Press (OK) button
- s) Now repeat steps I through M to enter the time of day and which days of the week you want to turn the corresponding output off (Note: make sure to choose the same days of the week to be **ON** in step J has you did in the previous program set up)
- t) Once programming is complete and the word **ADD** is again displayed and you are finished adding programs than just hit the (MAN 2/ESC) button twice to exit back to original run mode, (the indicator bar that goes with the corresponding output should be illuminated at the button only on times where the output it to be on for that day)

4.) Pulse Mode

This mode will give an output pulse time during a set time and days of the week that is programmed. More than one output pulse can be given in a day by adding a new program and using the pulse mode again. The pulse length will be anywhere from 1 to 99 seconds long depending on the predetermined time that was set in the, "*Cycle/Pulse Setting*", section on page 12.

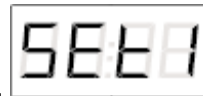

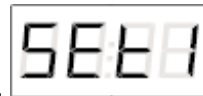
- a) Press and hold the (+PRG) button for 3 seconds,  is what shows on the LCD display (also you will see **prog** in the upper left corner of the display)
- b) Press the (OK) button to enter into the programming parameters (the word **ADD** will be shown now)
- c) Press the (OK) button, (information about the number of the new program



Pr.XX) example:  this just gives a numeric values to the memory location of this program

- d) Now press the (OK) button, (**Ch01** or **Ch02** should display)
- e) You can choose whether to control output 1 or output 2 by scrolling between them with the (+PRG) or (-MAN) buttons



- f) Press (OK) button,
- g) Use the (+PRG) or (-MAN) buttons to scroll through menu options so that the display looks like it does in step F EXCEPT the On in the upper left corner should not be illuminated only the Out and the \square symbol in the upper right hand corner should be illuminated (this is how this device is put into pulse mode)
- h) Press the (OK) button
- i) The two hours digits on the left side of the display should be blinking, adjust the numbers using the (+PRG) or (-MAN) buttons to set the desired hour that you want the output to come on and than press the (OK) button
- j) Now the two minutes digits are blinking on the right side of the display, adjust the numbers using the (+PRG) or (-MAN) buttons to the desired minute time that you want the output to come on and than press the (OK) button
- k) Now it is time to select which days of the week this program will be on for by pressing the (OK) button on either on or off along with the corresponding number in the top of the display that represents the days of the week,



example:

- l) Choose **ON** or **OFF** by using (+PRG) or (-MAN) to scroll between the two chooses and (OK) to enter the choose (the numbers at the top represent the days of the week by the number **1 = Monday** and the **7 = Sunday**)
- m) Once programming is done and the word **ADD** is again displayed and you are done adding programs than just hit the (MAN 2/ESC) button twice to exit back to original run mode, (the indicator bar that goes with the corresponding output should be illuminated at the button only on times where the output it to be on for that day)

5.) Random Switching Mode

This mode is displayed on the LCD screen by an illuminated the symbol  witch causes a random switching of the output in the time range from 10 to 120 minutes. (Example use: This mode is for irregular switching of appliances like a light, which simulates presence of people in the house.

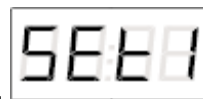

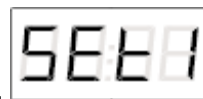
- a) Press and hold the (+PRG) button for 3 seconds,  is what shows on the LCD display (also you will see **prog** in the upper left corner of the display)



- b) Press the (+PRG) twice until the display shows  on the units LCD screen and the word MAN should also be illuminated
- c) Press (OK) button, (**Ch01** or **Ch02** should display)
- d) You can choose whether to control output 1 or output 2 by scrolling between them with the (+PRG) or (-MAN) buttons

- e) Press (OK) button, (**prog** should be illuminated in the upper left corner)

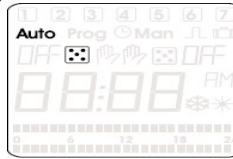

- f) Press the (+PRG) button, should now display on the units LCD screen



- g) Press (OK) button, display goes back to screen
- h) Press (MAN 2/ESC) button to go back to the original run mode (now the will be blinking on either the left side or right side depending on which output you selected to go on and off randomly)

6.) Manual

This mode allows for the output to permanently switched on or off by a short press or the (-MAN) button to control output one or (MAN2 / ESC) to control output two. This is done in the run mode operation for easy and quick control of both channel outputs. Pushing the button MAN buttons will override any other modes currently present at the time because it is the highest priority mode, see page 7 mode priorities diagram.

7.) Cycle/Pulse Output Setting

This sets the on and off cycle time for the repeat cycle and also the pulse output modes (step 2 and step 3 of the programming section). In the Pulse cycle mode, only the on time setting matters because it pulses on once for the preset time and at the end of the on time the output will remain off unless there is another program set for the pulse to go off again that day. In other words, the on time sets the pulse length and the off time doesn't matter unless you're in the repeat cycle mode.

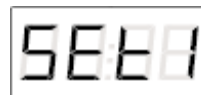

- a) Press and hold the (+PRG) button for 3 seconds, is what shows on the LCD display (also you will see **prog** in the upper left corner of the display)

- b) Press the (+PRG) button 3 times until the LCD display shows



and the should also be illuminated

- c) Press the (OK) button, (**Ch01** or **Ch02** should display)
- d) You can choose whether to set the output cycle pulse to output 1 or output 2 by scrolling between them with the (+PRG) or (-MAN) buttons

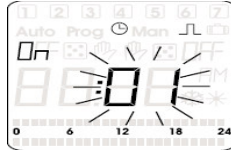

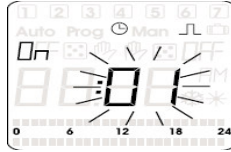
- e) Press the (OK) button, ( should now show on the display of the unit (the blinking two digits could be any thing from 01 to 99)
- f) Change the desired On time by using (+PRG) button to increase and the (-MAN) to decrease in increments of 1 second
- g) Press the (OK) button to save the value into memory (now the word **OFF** is illuminated)
- h) Again use the (+PRG) button to increase and the (-MAN) to decrease in increments of 1 second
- i) Press the (OK) button to save the value into memory, (the LCD screen will



- now return to  screen)
- j) Press the (MAN 2/ ESC) button to exit back to the original run mode

8.) Editing Programs

** If no programs are stored than the word FREE is shown.*

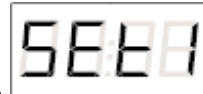

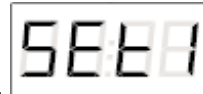
- a) Press and hold the (+PRG) button for 3 seconds,  is what shows on the LCD display (also you will see **prog** in the upper left corner of the display)
- b) Press the (OK) button to enter into the programming parameters, (the word **ADD** will be shown now)
- c) Press the (+PRG) button, (the unit's display will now show



- d) Press (OK) button (the time and day that Pr.00 is set for will display)
- e) Press the (MAN2 / ESC) button to display the **Pr.00** (you can choose to display the program number or the program time so this step is user choice)
- f) Use the (+PRG) button and the (-MAN) button to scroll to the correct program number you want to edit
- g) Press and hold the (OK) button for 3 seconds to enter the desired program you want to change
- h) Now follow the steps of the correct programming section that you want this device to operate in Normal Mode, Repeat Cycle Mode, Pulse Mode, etc...

9.) Deleting Programs

** To delete all programs saved in memory at once please see page 5," Reset all the Programs".*

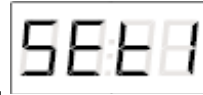

- a) Press and hold the (+PRG) button for 3 seconds,  is what shows on the LCD display (also you will see **prog** in the upper left corner of the display)
- b) Press the (OK) button to enter into the programming parameters (the word **ADD** will be shown now)



- c) Press the (+PRG) button twice (the LCD display shows )
- d) Press (OK) button (the time and day that Pr.00 is set for will display)
- e) Press the (MAN2 / ESC) button to display the **Pr.00**, (you can choose to display the program number or the program time so this step is user choice)
- f) Use the (+PRG) button and the (-MAN) button to scroll to the correct program number you want to delete
- g) Press and hold the (OK) button for 3 seconds to delete the selected program
- h) You can choose to delete another program by simply following steps F and G



again or wait 45 seconds and the device will return to the menu

- i) Press the (MAN 2 / ESC) button twice to exit back to original run mode

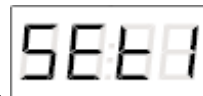

10.) Setting the Holiday Mode

Holiday mode can be programmed so that the unit doesn't have to be turned off, programs don't have to be changed, or even deleted during special times that you don't want the unit to be switching outputs on and off. This mode is used to keep off the outputs for the set time and date. The holiday mode will take precedence over any programmed mode. The only mode that will perform during holiday mode is the manual control mode.

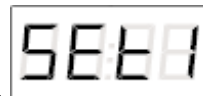

- a) Press and hold the (+PRG) button for 3 seconds,  is what shows on the LCD display (also you will see **prog** in the upper left corner of the display)



- b) Press (+PRG) button 4 times until  is on the unit's LCD screen
- c) Press (OK) button (**OFF** and  symbol is illuminated)
- d) Press (+PRG) button (now **ON** and  symbol is illuminated)

- e) Press the (OK) button to enter the starting year for holiday mode



(once in the display should have the last to digits blinking)

- f) By using the (+PRG) and the (-MAN) buttons you can change the year to your desired starting year
 g) Once you have the number on the correct year press the (OK) button to save it to the memory and move to the next set up option
 h) Device should have the first to digits blinking waiting for starting day over



holiday mode to be entered

- i) Again use the (+PRG) and the (-MAN) buttons to change the two digits to the correct day
 j) Press (OK) button to enter the day into the memory of the unit
 k) The day is still displayed on the first two digits and now the second two digits

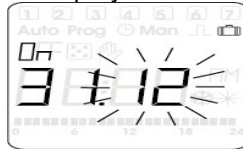

are blinking

- l) Once again by using the (+PRG) and the (-MAN) buttons you can scroll up and down to change the numeric values of the month (1-12) to set the starting month
 m) Press (OK) button (Now unit's display goes back to entering a year except the word **OFF** is now illuminated)
 n) Repeat steps F through L to set the holiday mode ending year, date, and time
 o) Once (OK) button is pressing to enter the holiday modes ending month the



LCD display will go back to

- p) Press the (MAN2 / ESC) button to return to original run mode